

ISOSCAN® EDS440/441

Insulation fault locators for localisation of insulation faults in unearthed DC, AC and three-phase power supply systems (IT systems)

From serial number: 2000...



ISOSCAN® EDS440/441

Insulation fault locators for localisation of insulation faults in unearthed DC, AC and three-phase power supply systems (IT systems)



Insulation fault locator EDS440-L

Device features

- Universal system concept
- Modular design, therefore easily adjustable to the given circumstances
- Measuring current transformers available in various sizes and versions
- CT connection monitoring
- 12 measuring channels for measuring current transformer series CTAC..., WR..., WS...
- Optional extension by 12 relay channels
- Fault memory behaviour selectable
- Up to 50 EDS insulation fault locators in the system, 600 measuring channels
- Response sensitivity: EDS440 2...10 mA, EDS441 0.2...1 mA
- AC residual current measurement with configurable response value
- Two alarm relays with one N/O contact each
- N/O or N/C operation selectable
- External test/reset
- Central display of faulty outgoing circuits
- Serial interface RS-485, BS bus address range 2...79, Modbus RTU
- Connection to higher-level control and visualisation systems possible

Certifications



Product description

The insulation fault locators ISOSCAN® EDS44x are used in connection with the ISOMETER® iso685-D-P or the locating current injector PGH to locate insulation faults in unearthed power supply systems (IT systems).

They detect locating current signals generated by the insulation monitoring device iso685-D-P or the locating current injector PGH and evaluate them correspondingly.

Up to 12 measuring current transformers can be connected to an EDS44x. In total, up to 50 insulation fault locators can be connected via an RS-485 interface (BS bus protocol) and thereby up to 600 outgoing circuits can be monitored.

Application

- Insulation fault location in AC, 3AC and DC IT systems
- Main circuits and control circuits in industrial plants and ships
- Diode-decoupled DC IT systems in power plants
- Systems for medical locations

Function description

When an insulation monitoring device detects the occurrence of an insulation fault, it starts the insulation fault location.

In the event of a first insulation fault, a residual current flows in IT systems that is primarily defined by the system leakage capacitances. The basic idea of the fault location is therefore closing the fault current circuit for a short period of time via a defined resistance. Due to this principle, a locating current, which contains an evaluable signal, is driven through the system voltage.

The locating current is generated by the locating current injector at regular intervals. It is limited in amplitude and time. Thereby, the system conductors are alternately connected to earth via a defined resistance. The resulting locating current depends on the size of the existing insulation fault and the system voltage. It is limited depending on the settings. During project planning it is important to observe that, even in unfavourable cases, there is no system part on which this locating current may cause harmful reactions.

The locating current flows from the locating current injector via the live lines to the insulation fault position taking the shortest way. From there, it flows through the insulation fault and the PE back to the locating current injector. This locating current pulse is detected by the measuring current transformer on the insulation fault path and signalled by the connected insulation fault locator.

System variants

The insulation fault locators EDS440 and EDS441 differ depending on their response sensitivity. The EDS440 is suitable for main circuits. The EDS441 can be used in control circuits and in circuits in medical locations.

	-L	-S	-LAB-4	-LAF-4
EDS440	<ul style="list-style-type: none"> • LED • BS bus • $I_{\Delta L} = 2 \dots 10 \text{ mA}$ • Main circuits • Digital inputs and outputs 	<ul style="list-style-type: none"> • No LED • BB bus • $I_{\Delta L} = 2 \dots 10 \text{ mA}$ • Main circuits • No internal voltage supply 		<ul style="list-style-type: none"> • LED • BS bus • $I_{\Delta L} = 10 \text{ mA}$ • Main circuits • Digital inputs and outputs
EDS441	<ul style="list-style-type: none"> • LED • BS bus • $I_{\Delta L} = 0.2 \dots 1 \text{ mA}$ • Control circuits • Digital inputs and outputs 	<ul style="list-style-type: none"> • No LED • BB bus • $I_{\Delta L} = 0.2 \dots 1 \text{ mA}$ • Control circuits • No internal voltage supply 	<ul style="list-style-type: none"> • LED • BS bus • $I_{\Delta L} = 0.2 \dots 1 \text{ mA}^*$ • Control circuits • Digital inputs and outputs 	

* High response sensitivity with large system leakage capacitances

** In combination with CTAF...SET series measuring current transformers

Device variants

EDS44...-L

Alarm messages are directly indicated on the device display

EDS44...-S

Alarm messages are displayed on the respective ISOMETER®

Option “W”

Devices with the suffix “W” feature increased shock and vibration resistance.

The electronics is covered with a special varnish to provide increased protection against mechanical stress and moisture.

Standards

Observe the applicable national and international standards. The EDS44x series meets the device standards:

- DIN VDE 0100-410 (VDE 0100-410)
- DIN EN 61557-9 (VDE 0413-9)
- IEC 61557-9
- DIN EN 50155 (VDE 0115-200)
- DIN EN 45545-2:2016

Operating and display elements EDS44x

EDS440-S



EDS440-L

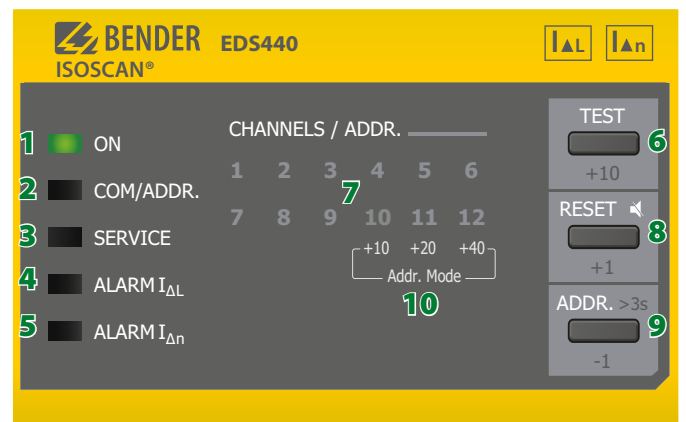

- 1 - The “ON” LED flashes until the device is ready for operation during power up.
The “ON” LED lights up when the device is turned on. A current transformer connection test is carried out every hour. During the test, the “ON” LED flashes.
- 2 - The “COM/ADDR.” LED flashes quickly while the device communicates via the RS-485 interface.
During insulation fault location, the LED flashes to indicate that the locating current injector is sending out a pulse: During the pulse phase, the LED is lit; during the pause, it is not lit. In the LAB procedure, the pulse can last up to one minute. Therefore, no constant “flashing” of the COM LED can be seen. The LED lights up continuously for the pulse time of up to 1 minute.
- 3 - The “SERVICE” LED lights up either when there is a device error, a connection fault of the measuring current transformers or an error message e.g. due to low-frequency residual currents, external magnetic fields, etc.
- 4 - The “ALARM $I_{\Delta L}$ ” LED signals the main alarm. The LED lights up when an insulation fault is detected (EDS function) on one of the measuring channels.
- 5 - The “ALARM $I_{\Delta n}$ ” LED lights up if the set response value for residual currents is exceeded. The factory setting for the response value is 10 A for the EDS440 and 1 A for the EDS441.

- 6 - The channel LEDs “1...12” light up:
A channel LED lights up if an insulation fault is detected on the respective measuring channel or if there is a residual current alarm.
The channel LEDs “1...12” flash:
If there is a connection fault of the measuring current transformer, the channel LED flashes slowly (1 Hz).
If there is an interference during insulation fault location, the channel LED flashes quickly (2 Hz).
- 7 - Pressing the TEST button triggers the self test of the device. In the address assignment mode, the address can be set in steps of ten. (+10)
- 8 - You can reset the fault memory using the RESET button. The fault memory can only be reset if it is activated and the fault has been eliminated.
In the address assignment mode, the address can be set in steps of one. (+1)
- 9 - Pressing the button for 3 seconds activates the address assignment mode. In the address assignment mode, the address can be set in steps of one (+1 and -1) and steps of ten (+10).
- 10 - Addr. Mode: Indication of the present tens counter by means of the channel LEDs 10, 11 and 12.

Connection to the voltage supply

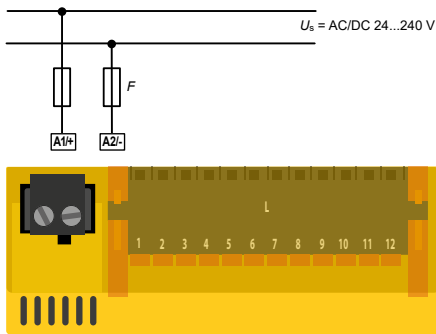

Back-up fuse voltage supply

If the device is supplied via an external power supply unit, the back-up fuse **F** at connection "A1/+ A2/-" must be selected in such a way that the feeding power supply unit is able to trip the DC-compatible back-up fuse.

Example: A back-up fuse of 650 mA/T is recommended when using a 24-V power supply unit (min. 1 A).

Connection to the X1 interface

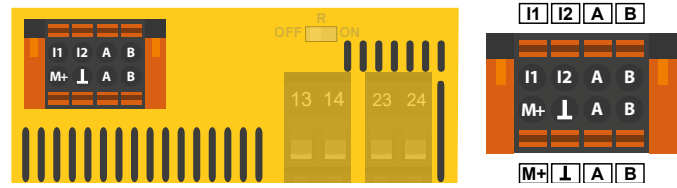

I1	Input 1	M+	Dig. current output
I2	Input 2	⊥	Ground
A	RS-485 A (input)	A	RS-485 A (output)
B	RS-485 B (input)	B	RS-485 B (output)

Connection of relays

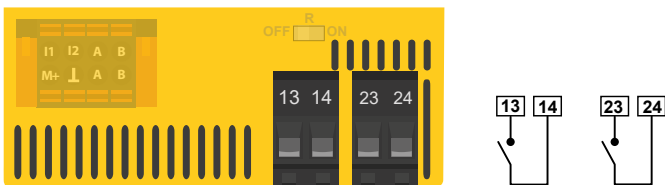

Alarm relay 1	13	N/O contact	Alarm relay 2	23	N/O contact
	14			24	

BS bus termination

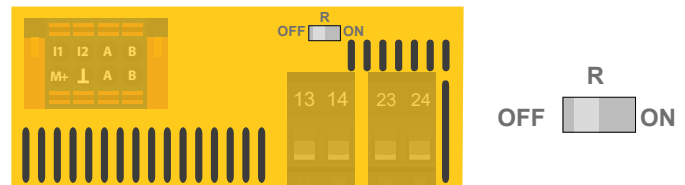

Activating a terminating resistor to define the first and the last device in the bus system.

ON	First and last device in a bus	OFF	All devices between the first and the last device in the bus
----	--------------------------------	-----	--

Connection to the k1-12/I1-12 interface

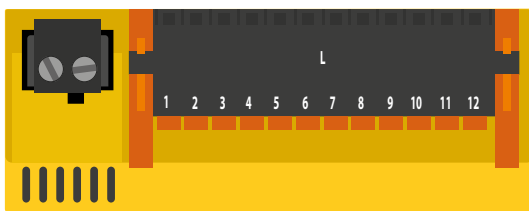

I1	Measuring CT 1	k1
I2	Measuring CT 2	k2
I3	Measuring CT 3	k3
I4	Measuring CT 4	k4
...
I12	Measuring CT 12	k12

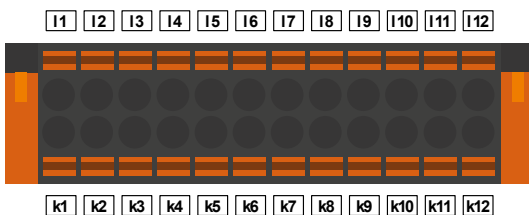

Connection measuring current transformer CTAC..., WR..., WS... series

For insulation fault location, the measuring current transformers of the CTAC... (closed), WR... (rectangular) and WS... (split-core) series are used.

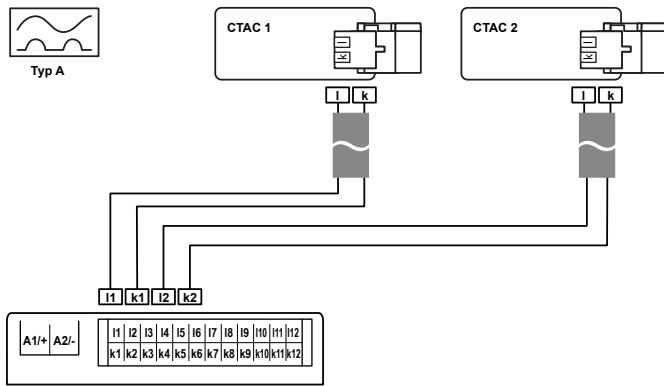

Connection of CTAF...SET series measuring current transformers to EDS440-LAF-4

For insulation fault location, the measuring current transformers of the CTAF...SET series are used.

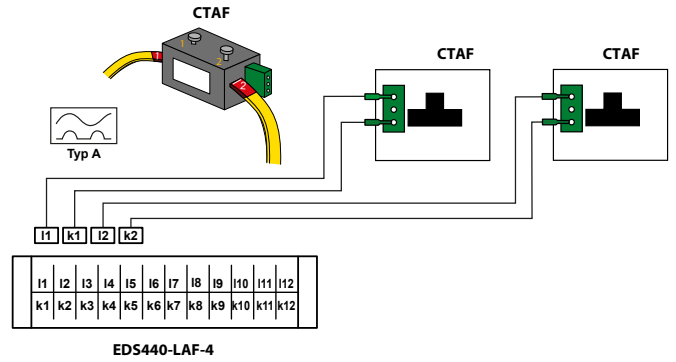

Connecting measuring current transformers of the CTBC... series to EDS441-LAB-4

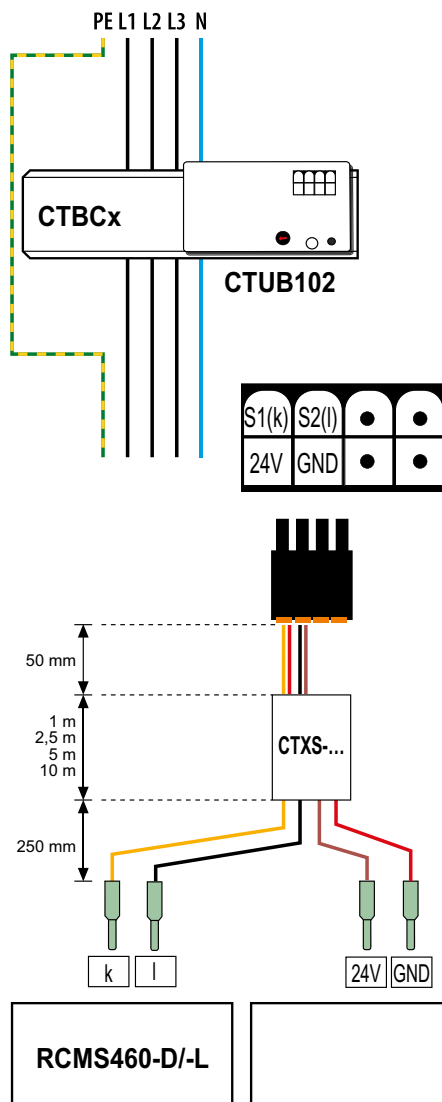

Wiring diagram to 3(N)AC system with iso685-D-P

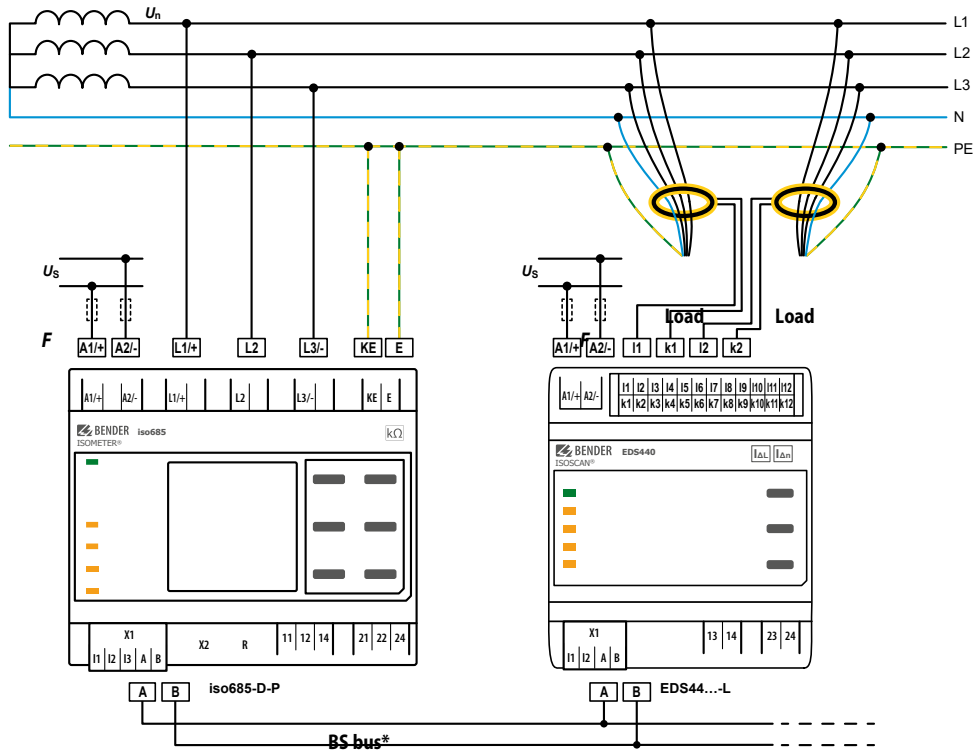

For systems > 690 V and with overvoltage category III a fuse for the connection to the system to be monitored must be provided. Recommendation: 2A fuses.

* Communication between iso685-x-P and EDS44x-L only via BS bus (RS-485).

Wiring diagram to DC system with iso685-D-P

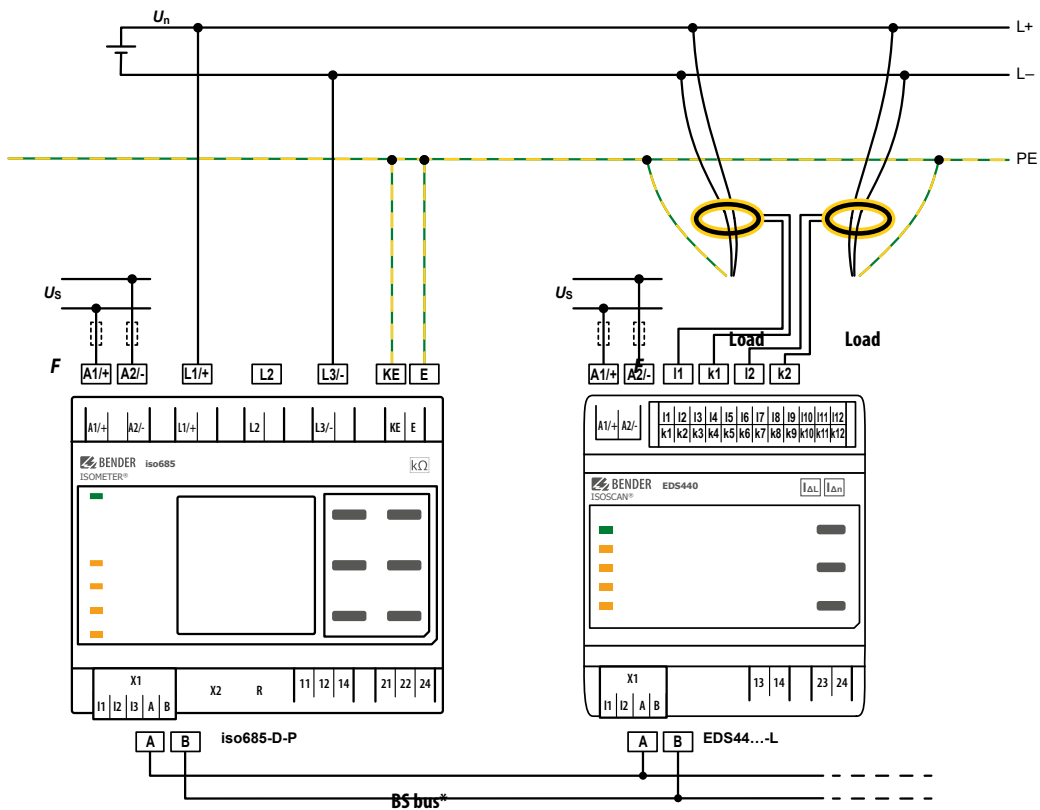

* Communication between iso685-x-P and EDS44x-L only via BS bus (RS-485).

Wiring diagram to AC system with ISOMETER® iso685-D-P

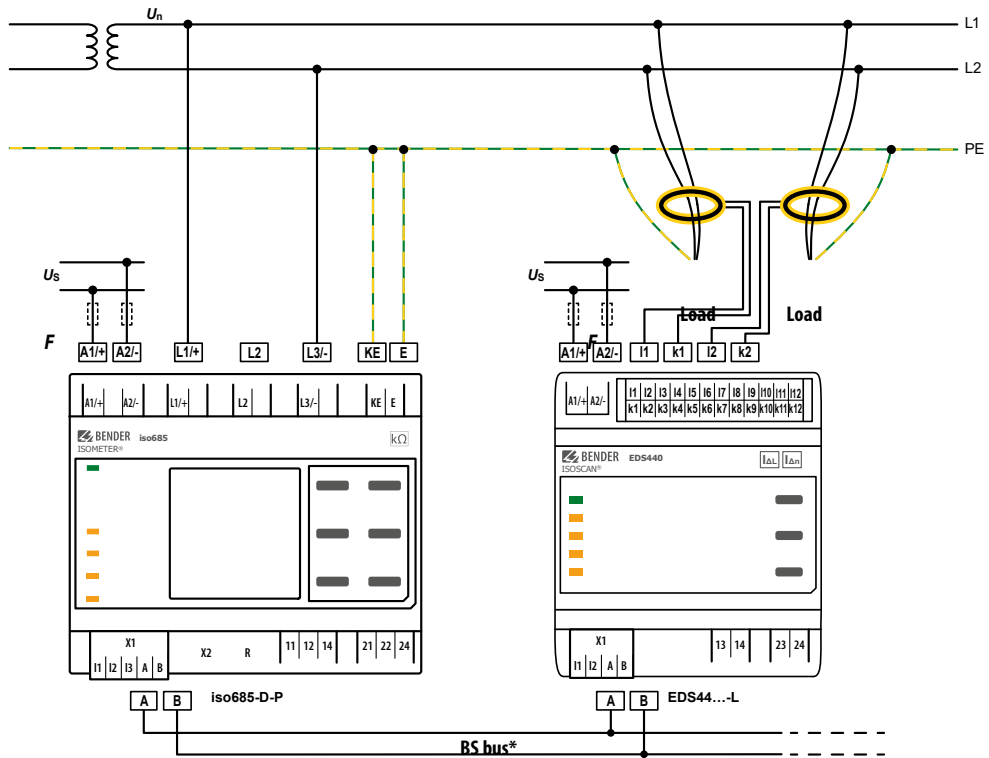

* Communication between iso685-x-P and EDS44x-L only via BS bus (RS-485).

Connection example: ISOMETER® iso685-D-P, EDS440-S, IOM441-S and EDS440-L

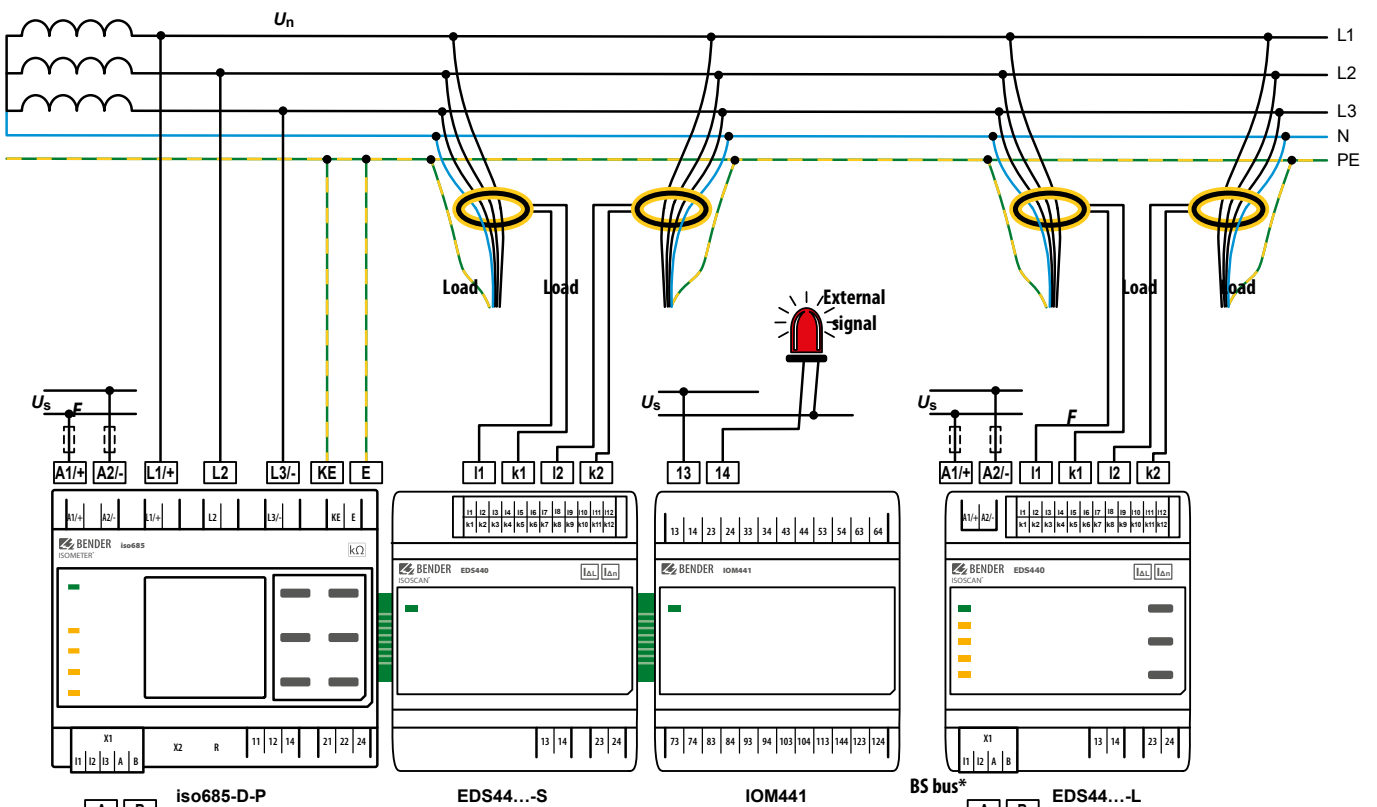

* Communication between iso685-x-P and EDS44x-L only via BS bus (RS-485).

Technical data

Insulation coordination acc. to IEC 60664-1/IEC 60664-3

Definitions	
Supply circuit (IC1)	A1, A2
Output circuit 1 (IC2)	13, 14
Output circuit 2 (IC3)	23, 24
Control circuit (IC4)	(A1, A2), (13,14)-(23,24)-(X1, X3)
Rated voltage	1000 V
Overvoltage category	III
Range of use	≤ 2000 m AMSL
Rated impulse voltage	
IC1/(IC2-4)	4 kV
IC2/(IC3-4)	4 kV
IC3/(IC4)	4 kV
Rated insulation voltage	
IC1/(IC2-4)	AC 250 V
IC2/(IC3-4)	250 V
IC3/IC4	250 V
Pollution degree outside ($U_n < 690$ V)	3
Pollution degree outside ($U_n > 690 < 1000$ V)	2
Protective separation (reinforced insulation) between	
IC1/(IC2-4)	Overvoltage category III, 1000 V
IC2/(IC3-4)	Overvoltage category III, 300 V
IC3/IC4	Overvoltage category III, 300 V
Voltage tests (routine test) acc. to IEC 61010-1	
IC2/(IC3-4)	AC 2.2 kV
IC3/IC4	AC 2.2 kV

Supply voltage

Supply voltage range U_s EDS44...-L (...-LAB, ...-LAF)	AC/DC 24...240 V
Supply voltage range U_s EDS44...-S	DC 24 V
Tolerance of U_s	-20...+15%
Frequency range of U_s	DC, 50...400 Hz ^(1/2)
Tolerance of the frequency range of U_s	-5...+15 %
Power consumption, typically 50 Hz (400 Hz) EDS44...-L	≤ 4 W/7 VA (≤ 4 W, 28 VA)
Power consumption, typically (DC via BB bus) EDS44...-S	≤ 1 W

Response values

Response value insulation fault location ($I_{\Delta L}$) EDS440	2...10 mA
Response value insulation fault location ($I_{\Delta L}$) EDS441	0.2...1 mA
Relative uncertainty ($I_{\Delta L}$) EDS440	±30 %, min. ±2 mA ⁽³⁾
Relative uncertainty ($I_{\Delta L}$) EDS441	±30 %, min. ±0.2 mA ⁽³⁾
Response value residual current measurement ($I_{\Delta n}$) EDS440	100 mA...10 A
Response value residual current measurement ($I_{\Delta n}$) EDS441	100 mA...1 A
Relative uncertainty ($I_{\Delta n}$) EDS44x (42...60 Hz)	±5 %
Relative uncertainty ($I_{\Delta n}$) EDS44x (61...1000 Hz)	-20...0 %
Hysteresis	20 %

Time response

Scanning time for all channels insulation fault location ($I_{\Delta L}$)	profile-dependent, min. 6 s
Response time residual current measurement ($I_{\Delta n}$)	≤ 400 ms
Response time for measuring current transformer monitoring	max. 18 min

Measuring circuit

Nominal system voltage U_n EDS440	refer to locating current injector (e.g. ISOMETER® iso685-D-P)
Nominal system voltage U_n EDS441	AC 230 V, DC 220 V
Tolerance of U_n EDS441	AC ±15 %, DC ±40 %
Measuring current transformers external for EDS440 type	CTAC... , WR... , WS...
Measuring current transformers external for EDS441 type	WS... /8000
Measuring current transformers external for EDS441-LAB	CTBC...
Measuring current transformers external for EDS440-LAF	CTAF...
Load EDS440	47 Ω
Load EDS441, EDS440-LAF	1.5 kΩ
Rated insulation voltage measuring current transformers	800 V

Connection EDS measuring current transformers

Single wire ≥ 0.75 mm ²	0...1 m
Single wire, twisted ≥ 0.75 mm ²	1...10 m
Shielded cable ≥ 0.5 mm ²	10...40 m
Recommended cable (shielded, shield connected to PE on one side)	J-Y (St) Y min. 2 x 0.8

Measuring ranges insulation fault location $I_{\Delta L}$

Rated frequency range	DC, 16.7...1000 Hz
Measuring range insulation fault location ($I_{\Delta L}$) EDS440	1.5...50 mA
Measuring range insulation fault location ($I_{\Delta L}$) EDS441	0.15...5 mA
Maximum permissible residual current	refer to "Diagrams" in the manual

Measuring range residual current measurement $I_{\Delta n}$

Measuring range residual current measurement ($I_{\Delta n}$) EDS440	100mA...20 A
Rated frequency range EDS440-x	50...1000 Hz
Measuring range residual current measurement ($I_{\Delta n}$) EDS441	100mA...2 A
Rated frequency range EDS441-x	50...60 Hz

LEDs

ON (operation LED)	green
COM	yellow
SERVICE	yellow
$I_{\Delta L}$ ALARM	yellow
$I_{\Delta n}$ ALARM	yellow
1...12 channel indication	yellow

Digital inputs

Number	2
Operating mode, adjustable	active high, active low
Function	none, test, reset
Voltage level	Low DC -5...5 V, High DC 11...32 V

Digital current output

Number	1
Function	none, $I_{\Delta L}$ alarm, $I_{\Delta n}$ alarm, device error, current transformer connection fault, common alarm, BS bus malfunction
Current	0 mA DC inactive, 20 mA DC active
Tolerance	±10 %
Load resistance	$R \leq 500 \Omega / PR \geq 0.25W$

Buzzer

Number	1
Function	none, $I_{\Delta L}$ alarm, $I_{\Delta n}$ alarm, device error, transformer connection fault, insulation fault location active, common alarm

Interfaces

Interface/protocol	RS-485 BS bus Modbus RTU
Data rate BS bus	9.6 kBaud/s
Data rate Modbus RTU	9.6 19.2 37.4 57.6 115 kBaud/s
Cable length	≤ 1200 m
Cable: twisted pair, one end of shield connected to PE	recommended: J-Y (St) Y min. 2 x 0.8
Connection	X1.A, X1.B
Terminating resistor	120 Ω, can be activated internally
Device address, BS bus	0, 2...79 (optional 0, 2...159)

Switching elements

Number	2 N/O contacts
Operating mode	N/C operation / N/O operation
Function contact 13,14	none, $I_{\Delta L}$ alarm, $I_{\Delta n}$ alarm, device error, CT connection fault, common alarm, BS bus malfunction
Function contact 23,24	none, $I_{\Delta L}$ alarm, $I_{\Delta n}$ alarm, device error, CT connection fault, common alarm, BS bus malfunction
Electrical endurance under rated operating conditions	30000 hrs.
Rated operational voltage	AC 250 V
Rated operational current	7 A

Technical data (continuation)

Rated insulation voltage	4 kV
Kontaktaten nach IEC 60947-5-1	
Gebrauchskategorie	AC-13/AC-14/DC-12/DC-12/DC-12/DC-12
Bem.betriebsspannung	230 V/230 V/24 V/48 V/110 V/220 V
Bem.betriebsstrom	5 A/3 A/1 A/1 A/0.2 A/0.1 A
Max. switching capacity	300 W/2770 VA
Max. switching voltage	DC 30 V/AC 277 V
Minimum contact rating	1 mA at AC/DC ≥ 10 V

Environment/EMC

EMC	IEC 61326-2-4
-----	---------------

Ambient temperatures

Operating temperature	-25 °C... +55 °C
Transport	-40 °C... +85 °C
Storage	-25 °C... +70 °C

Classification of climatic conditions acc. to IEC 60721:

Stationary use (IEC 60721-3-3)	3K23 (no condensation, no formation of ice)
Transport (IEC 60721-3-2)	2K11
Long-term storage (IEC 60721-3-1)	1K22

Classification of mechanical conditions acc. to IEC 60721:

Stationary use (IEC 60721-3-3)	3M11
Transport (IEC 60721-3-2)	2M4
Long-term storage (IEC 60721-3-1)	1M12

Connection

Connection type	pluggable screw-type terminal or push-wire terminal
-----------------	---

Screw-type terminals:

Tightening torque	0.5...0.6 Nm (5...7 lb-in)
Conductor sizes	AWG 24-12
Stripping length	7 mm
rigid/flexible	0.2...2.5 mm ²
flexible with ferrule, with/without plastic sleeve	0.25...2.5 mm ²
Multiple conductor, rigid	0.2...1 mm ²
Multiple conductor, flexible	0.2...1.5 mm ²
Multiple conductor, flexible with ferrule without plastic sleeve	0.25...1 mm ²
Multiple conductor, flexible with TWIN ferrule with plastic sleeve	0.5...1.5 mm ²

Push-wire terminals:

Conductor sizes	AWG 24-12
Stripping length	10 mm
rigid/flexible	0.2...2.5 mm ²
flexible with ferrule, with/without plastic sleeve	0.25...2.5 mm ²
Multiple conductor, flexible with TWIN ferrule with plastic sleeve	0.5...1.5 mm ²

Push-wire terminals X1, X2:

Conductor sizes	AWG 24-16
Stripping length	10 mm
rigid/flexible	0.2...1.5 mm ²
flexible with ferrule without plastic sleeve	0.25...1.5 mm ²
flexible with ferrule with plastic sleeve	0.25...0.75 mm ²

Other

Operating mode	continuous operation
Mounting	at an ambient temperature > 55 °C vertical mounting required at an ambient temperature < 55 °C mounting optional
Degree of protection internal components	IP40
Degree of protection terminals	IP20
DIN rail mounting acc. to	IEC 60715
Screw fixing	2 x M4 with mounting clip
Enclosure material	polycarbonate
Flammability class	UL 94V-0
Dimensions (W x H x D)	72 x 93 x 63
Documentation number	D00201
Weight	approx. 122 g (EDS44x-S) approx. 242 g (EDS44x-L, ...-LAB, ...-LAF)

"W" option data deviating from the standard version

Devices with the suffix "W" feature increased shock and vibration resistance. The electronics is covered with a special varnish to provide increased protection against mechanical stress and moisture.

Ambient temperatures:

Operating temperature	-40...+70 °C
Transport	-40...+85 °C
Long-term storage	-25...+70 °C

Classification of climatic conditions acc. to IEC 60721:

Stationary use (IEC 60721-3-3)	3K23 (condensation and formation of ice possible)
--------------------------------	---

Classification of mechanical conditions acc. to IEC 60721:

Stationary use (IEC 60721-3-3)	3M11
--------------------------------	------

- ¹⁾ = At a frequency > 200 Hz, the connection of X1 and k1-12/11-12 must be insulated. Only permanently installed devices which at least have overvoltage category CAT2 (300 V) may be connected.
- ²⁾ = Only 50/60 Hz are permitted for UL applications.
- ³⁾ = Residual current effect of > 100 mA results in a greater relative uncertainty.

Dimension diagram

Dimensions in mm

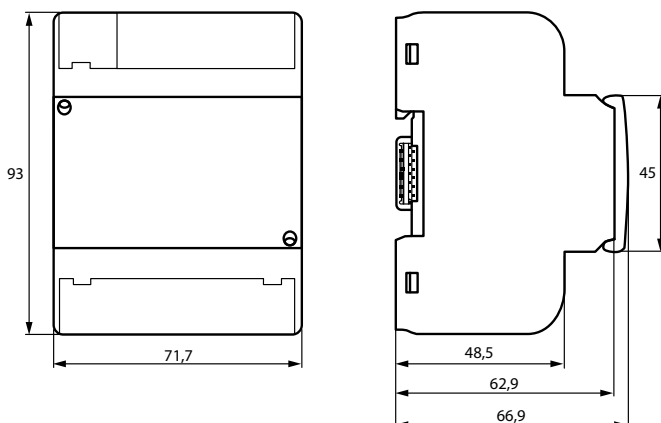

Ordering information

Response value	Supply voltage U_s ¹⁾	LED display	Option "W"	Type	Art. No.
			-40...+70 °C, 3K23, 3M11		
2...10 mA	DC 24 V	-	-	EDS440-S-1	B91080201
			■	EDS440W-S-1	B91080201W
	AC/DC 24...240 V	■	-	EDS440-L-4	B91080202
			■	EDS440W-L-4	B91080202W
0.2...1 mA	DC 24 V	-	-	EDS441-S-1	B91080204
			■	EDS441W-S-1	B91080204W
	AC/DC 24...240 V	■	-	EDS441-L-4	B91080205
			■	EDS441W-L-4	B91080205W
			-	EDS441-LAB-4	B91080207
			■	EDS441W-LAB-4	B91080207W
10 mA	AC/DC 24...240 V	■	-	EDS440-LAF-4	B91080209

¹⁾ Absolute values

Suitable system components

Supply voltage U_s	Type	Art. No.
AC/DC 24 V \pm 20 %	DI-1PSM (RS-485 repeater)	B95012044
Supplied by USB interface	DI-2USB (interface converter RS-485/USB) with USB cable	B95012045
12-fold relay module	IOM441-S (input/output module)	B95012057

Accessories

Description	Art. No.
Plug kit, screw terminals ¹⁾	B91080901
Plug kit, push-wire terminals	B91080902
Mechanical accessories (terminal cover, 2 mounting clips) ¹⁾	B91080903
BB bus 4TE Connector ²⁾	B98110002

¹⁾ included in the scope of delivery

²⁾ included in the scope of delivery of EDS44x-S-4

Measuring current transformer for EDS440

Design type	Internal diameter/mm	Type	Art. No.
circular	20	CTAC20	B98110005
	35	CTAC35	B98110007
	60	CTAC60	B98110017
	120	CTAC120	B98110019
	210	CTAC210	B98110020
split-core	20 x 30	WS20x30	B98080601
	50 x 80	WS50x80	B98080603
	80 x 120	WS80x120	B98080606

Alternative measuring current transformer from the Bender program

Design type	Internal diameter/mm	Type	Art. No.
circular	10	W10/600	B911761
	20	W0-S20	B911787
	35	W1-S35	B911731
	70	W2-S70	B911732
	105	W3-S105	B911733
	140	W4-S140	B911734
	210	W5-S210	B911735
	rectangular	70x175	WR 70x175S
115x305		WR 115x305S	B911739
150x350		WR 150x350S	B911740
200x500		WR 200x500S	B911763
split-core	50x80	WS 50x80S	B911741
	80x80	WS 80x80S	B911742
	80x120	WS 80x120S	B911743
	80x160	WS 80x160S	B911755

For further information regarding the measuring current transformers, refer to the respective data sheets.

Measuring current transformer for EDS441

Design type	Internal diameter/mm	Type	Art. No.
circular	20	CTAC20/01	B98110006
	35	CTAC35/01	B98110008

Alternative measuring current transformer from the Bender program

Design type	Internal diameter/mm	Type	Art. No.
circular	10	W10/8000	B911759
	35	W1-35/8000	B911756
circular, 6-fold	10	W10/8000-6	B911900
split-core	20 x 30	WS20x30/8000	B911764
	50 x 80	WS50x80/8000	B911757

For further information regarding the measuring current transformers, refer to the respective data sheets.

Characteristic curve for response sensitivity

Network configuration, mains voltage, mains frequency, leakage capacitance and test current influence the responsiveness of the EDS system.

The resulting insulation resistance response value R_{an} is determined step by step using the formulas and diagrams.

- Evaluation of system types 3AC, AC or DC
 - 3AC or AC system: $U_n = 0.6 U_n$
 - DC system: $U_n = 1.0 U_n$
- Calculate the standardised response value $R_{an}(C_e = 0 \mu F)$ with an assumed leakage capacitance of $C_e = 0 \mu F$ and the EDS response value $I_{an} = 5 \text{ mA}$: $R_{an}(C_e = 0 \mu F) = U_n / I_{an}$

Measuring current transformer for EDS441-LAB

Design type	Internal diameter/mm	Type	Art. No.
circular	20	CTUB104-CTBC20P	B78120033
	35	CTUB104-CTBC35P	B78120034
	60	CTUB104-CTBC60P	B78120035

Measuring current transformer for EDS440-LAF

Design type	mm	Type	Art. No.
flexible	500	CTAF500SET	B98110022
	1000	CTAF1000SET	B98110023

- Extract correction factor K from the diagram by forming the product with evaluated U_n and real leakage capacitance C_e .

- Calculate real response value:
 $R_{an} = K \times R_{an}(C_e = 0 \mu F)$

Example for a system with AC 230 V:

- to 1) = 138 V
- to 2) at 5 mA = 27.6 kΩ
- to 3) at 10 μF = 0.8
- to 4) = 22 kΩ

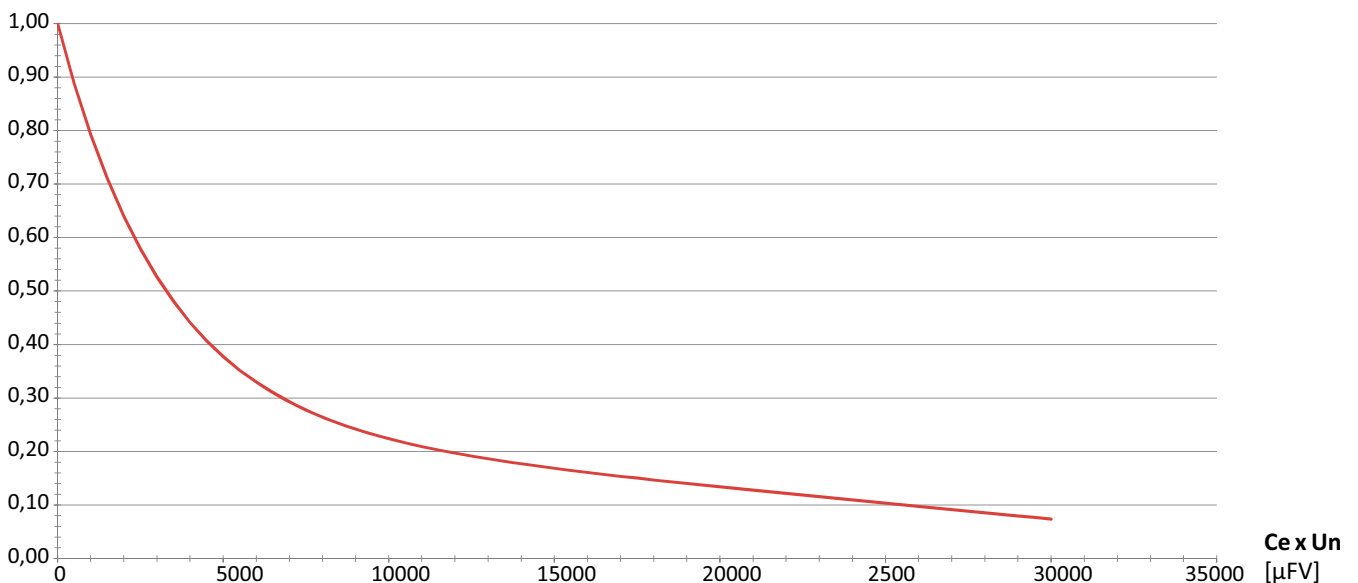

Fault curve EDS440.../EDS441...

An insulation fault location beyond the grey area causes an error message. The EDS44...-L indicates error messages via flashing LEDs. Use an EDS44...-S, then the fault messages are indicated via the ISOMETER®.

EDS440

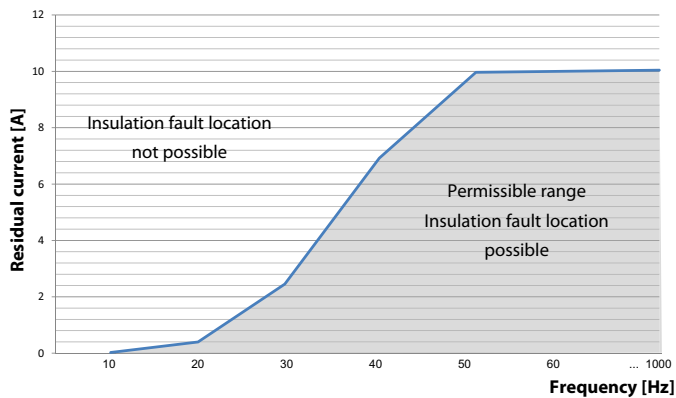

EDS441

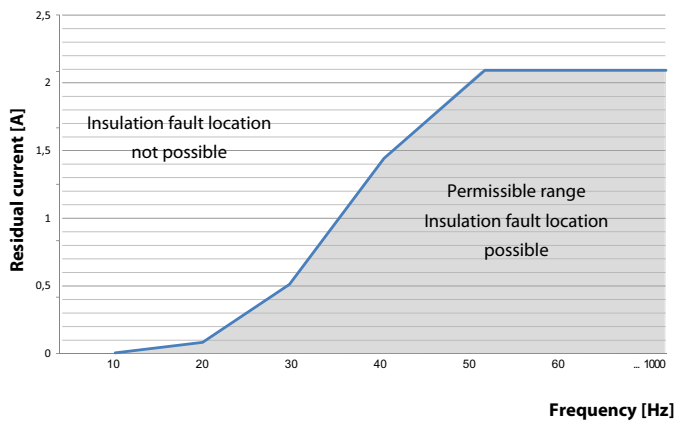

Bender GmbH & Co. KG

Londorfer Straße 65 • 35305 Grünberg • Germany
Tel.: +49 6401 807-0 • info@bender.de • www.bender.de



BENDER Group