



# CMD420/421

## Current monitoring device

for monitoring of 3AC current with current transformer for overcurrent **or** undercurrent or in window mode for overcurrent **and** under current

Software version CMD420: D287 V1.1x

Software version CMD421: D294 V1.1x





**Bender GmbH & Co. KG**

Postfach 1161 • 35301 Grünberg • Germany  
Londorfer Str. 65 • 35305 Grünberg • Germany  
Tel.: +49 6401 807-0 • Fax: +49 6401 807-259  
E-Mail: [info@bender.de](mailto:info@bender.de) • [www.bender.de](http://www.bender.de)

© Bender GmbH & Co. KG

All rights reserved.  
Reprinting only with permission of the publisher.  
Subject to change!

Photos: Bender archives

# Table of Contents

<b>1. Important information</b>	<b>5</b>
1.1 How to use this manual	5
1.2 Technical support: service and support	5
1.3 Training courses	6
1.4 Delivery conditions, warranty and liability	7
1.5 Inspection, transport and storage	7
1.6 Warranty and liability	7
1.7 Disposal	8
<b>2. Safety instructions</b>	<b>9</b>
2.1 General safety instructions	9
2.2 Work activities on electrical installations	9
2.3 Intended use	9
<b>3. Function</b>	<b>11</b>
3.1 Device features	11
3.2 Description of function	11
3.2.1 Window discriminator function	11
3.2.2 Automatic self test	12
3.2.3 Manual self test	12
3.2.4 Malfunction	12
3.2.5 Fault memory	12
3.2.6 Setting the number of reload cycles	12
3.2.7 Erasable history memory	12
3.2.8 Assigning alarm categories to alarm relays K1/K2	13
3.2.9 Delay times $t$ , $t_{on}$ and $t_{off}$	13
3.2.10 Password protection (on, OFF)	13
3.2.11 Factory setting FAC	13
3.2.12 Transformation ratio of the current transformers	14
<b>4. Installation, connection and commissioning</b>	<b>15</b>
4.1 Installing the device	15
4.2 Connection of the device	16
4.3 Commissioning	17
4.4 Factory setting	17
4.5 Maintenance	18

<b>5. Operation and configuration .....</b>	<b>19</b>
5.1 Display elements in use .....	19
5.2 Function of the operating elements .....	20
5.3 Menu structure .....	21
5.4 Display in standard mode .....	22
5.5 Display in menu mode .....	23
5.5.1 Parameter query and setting: overview .....	23
5.5.2 Changeover from overcurrent to undercurrent mode or to window mode .....	25
5.5.3 Response value setting for overcurrent: .....	26
5.5.4 Setting the fault memory and alarm relay operating mode .....	27
5.5.5 Assigning alarm categories to the alarm relays .....	28
5.5.6 Setting time delays .....	29
5.5.7 Changing from overcurrent operation to window operation .....	30
5.5.8 Setting the transformation ratio for external current transformer .....	31
5.5.9 Factory setting and password protection .....	31
5.5.10 Restore factory setting .....	32
5.5.11 Device information query .....	33
5.5.12 History memory query .....	33
<b>6. Technical data .....</b>	<b>35</b>
6.1 Data in tabular form .....	35
6.2 Standards, approvals and certifications .....	39
6.3 Label for modified versions .....	39
6.4 Ordering details .....	39
6.5 Revision history .....	40

# 1. Important information

## 1.1 How to use this manual



This manual is intended for **qualified personnel** working in electrical engineering and electronics!

Important notes and information are marked with the following symbols.



This signal word indicates that there is a **high risk of danger** that will result in **electrocution** or **serious injury** if not avoided.



This signal word indicates a **medium risk of danger** that can lead to **death** or **serious injury** if not avoided.



This signal word indicates a **low level risk** that can result in **minor** or **moderate injury or damage to property** if not avoided.



This symbol denotes information intended to assist the user in making **optimum use** of the product.

## 1.2 Technical support: service and support

For commissioning and troubleshooting Bender offers you:

### First level support

Technical support by phone or e-mail for all Bender products

- Questions concerning specific customer applications
- Commissioning
- Troubleshooting

Telephone: +49 6401 807-760\*

Fax: +49 6401 807-259

In Germany only: 0700BenderHelp (Tel. and Fax)

E-mail: support@bender-service.de

### Repair service

Repair, calibration, update and replacement service for Bender products

- Repairing, calibrating, testing and analysing Bender products
- Hardware and software update for Bender devices
- Delivery of replacement devices for faulty or incorrectly delivered devices
- Extended warranty with in-house repair service or replacement device at no extra cost

Telephone: +49 6401 807-780\*\* (technical issues)  
+49 6401 807-784\*\*, -785\*\* (sales)

Fax: +49 6401 807-789

E-mail: [repair@bender-service.de](mailto:repair@bender-service.de)

Please send the devices for **repair** to the following address:

Bender GmbH, Repair-Service, Londerfer Str. 65, 35305 Gruenberg

### Field service

On-site service for all Bender products

- Commissioning, parameter setting, maintenance, troubleshooting
- Analysis of the electrical installation in the building (power quality test, EMC test, thermography)
- Practical training courses for customers

Telephone: +49 6401 807-752\*\*, -762 \*\* (technical issues)  
+49 6401 807-753\*\* (sales)

Fax: +49 6401 807-759

E-mail: [fieldservice@bender-service.de](mailto:fieldservice@bender-service.de)

Internet: [www.bender-de.com](http://www.bender-de.com)

\*Available from 7.00 a.m. to 8.00 p.m. 365 days a year (CET/UTC+1)

\*\*Mo-Thu 7.00 a.m. - 8.00 p.m., Fr 7.00 a.m. - 13.00 p.m

## 1.3 Training courses

Bender provides training on how to use the universal measuring device.

Current dates of training courses and workshops can be found on the Internet at <http://www.bender.de> -> Know-how -> Seminars

## 1.4 Delivery conditions, warranty and liability

The conditions of sale and delivery set out by Bender GmbH apply.

For software products, the "Softwareklausel zur Überlassung von Standard-Software als Teil von Lieferungen, Ergänzung und Änderung der Allgemeinen Lieferbedingungen für Erzeugnisse und Leistungen der Elektroindustrie" (software clause in respect of the licensing of standard software as part of deliveries, modifications and changes to general delivery conditions for products and services in the electrical industry) set out by the ZVEI (Zentralverband Elektrotechnik- und Elektronikindustrie e.V., - German Electrical and Electronic Manufacturers' Association) also applies.

Conditions of sale and delivery can be obtained from Bender in printed or electronic format.

## 1.5 Inspection, transport and storage

Inspect the dispatch and equipment packaging for damage, and compare the contents of the package with the delivery documents. In the event of damage in transit, please contact Bender immediately.

The devices must only be stored in areas where it is protected from dust, humidity and spray or dripping water, and in which the specified storage temperatures can be assured.

## 1.6 Warranty and liability

Warranty and liability claims in the event of injury to persons or damage to property are excluded if they can be attributed to one or more of the following causes:

- Improper use of the device.
- Incorrect mounting, commissioning, operation and maintenance of the device.
- Failure to observe the instructions in this operating manual regarding transport, commissioning, operation and maintenance of the device.
- Unauthorised changes to the device made by parties other than the manufacturer.
- Non-observance of technical data.
- Repairs carried out incorrectly and the use of replacement parts or accessories not approved by the manufacturer.
- Catastrophes caused by external influences and force majeure.
- Mounting and installation with device combinations not recommended by the manufacturer.

This operating manual, especially the safety instructions, must be observed by all personnel working on the device. Furthermore, the rules and regulations that apply for accident prevention at the place of use must be observed.

## 1.7 Disposal

Abide by the national regulations and laws governing the disposal of this device. Ask your supplier if you are not sure how to dispose of the old equipment.

The directive on waste electrical and electronic equipment (WEEE directive) and the directive on the restriction of certain hazardous substances in electrical and electronic equipment (RoHS directive) apply in the European Community. In Germany, these policies are implemented through the "Electrical and Electronic Equipment Act" (ElektroG). According to this, the following applies:

- Electric and electronic equipment are not to be included in household waste.
- Batteries and accumulators are not to be included in household waste but must be disposed of in accordance with the regulations.
- Old electrical and electronic equipment from users other than private households which was introduced to the market after 13th August 2005 must be taken back by the manufacturer and disposed of properly.

For more information on the disposal of Bender devices, refer to our website at [www.bender.de](http://www.bender.de) -> Service & support



## 2. Safety instructions

### 2.1 General safety instructions

Part of the device documentation in addition to this manual is the enclosed "Safety instructions for Bender products".



Read the operating manual **before** starting to install, connect and commission the device. After successful commissioning, keep the manual within easy reach for future reference.

### 2.2 Work activities on electrical installations



Only **qualified personnel** are permitted to carry out the work necessary to install, commission and run a device or system.



**DANGER**

#### **Risk of fatal injury from electric shock**

Touching live parts of the system carries the risk of:

- A fatal electric shock
- Damage to the electrical installation
- Destruction of the device

Before installing the device and before working on the connections of the device, make sure that the system is de-energised. The rules for working on electrical systems must be observed.

If the device is used outside the Federal Republic of Germany, the applicable local standards and regulations must be complied with.

### 2.3 Intended use

The current monitoring device CMD420 resp. CMD421 monitors a three-phase system and also three different AC systems for undercurrent or overcurrent, and in window mode for undercurrent and overcurrent. For current measurement, three external standard current transformers are to be connected according to the wiring diagram. The transformation ratio ( $n = x/1 \text{ A}$  resp.  $n = x/5 \text{ A}$ ) can be set in the range from 1...2000.

In order to meet the requirements of the applicable standards, customised parameter settings must be made on the equipment in order to adapt it to local equipment and operating conditions. Please heed the limits of the range of application indicated in the technical data.

Any use other than that described in this manual is regarded as improper.



## 3. Function

### 3.1 Device features

- Undercurrent and overcurrent monitoring in AC systems, current monitoring with window discriminator function
- Current monitoring using standard current transformers: x/ 1 A (CMD420), x/ 5 A (CMD421)
- Two separately adjustable alarm relays with one changeover contact each (K1, K2)
- Fault memory behaviour for the alarm relays selectable
- N/C or N/O operation selectable for K1, K2
- Digital measured value display via multi-functional LC display
- LEDs: Power On (ON), Alarm 1 (AL1) and Alarm 2 (AL2)
- Start-up delay, response delay and delay on release
- Adjustable switching hysteresis
- r.m.s. value measurement AC
- History memory for the operating value
- Cyclical self test
- Test and reset button
- Password protection to prevent unauthorised changes being made to device settings
- Sealable transparent cover
- Available with screw-type or push-wire terminals

### 3.2 Description of function

Once the supply voltage is applied, the start-up delay begins. Measured values changing during this time do not influence the switching state of the alarm relays.

The devices provide two separately adjustable response values (overcurrent/undercurrent). When the measuring quantity exceeds the response value ("Alarm 2") or falls below the response value ("Alarm 1"), such as is the case with window discriminator function, the time of the response delays " $t_{on1/2}$ " begins. When the response delay has elapsed, the alarm relays switch and the alarm LEDs light. If the measured value falls below or exceeds the release value (response value plus hysteresis) after the alarm relays have switched, the pre-defined delay on release starts " $t_{off}$ ". Once " $t_{off}$ " has elapsed, the alarm relays switch back to their initial position. With the fault memory activated, the alarm relays do not change their actual state until the reset button R is pressed.

#### 3.2.1 Window discriminator function

This operating mode can be used to monitor the measured current for two response values, overcurrent and undercurrent.

This operating mode (In) can be selected from the SEt menu.

Changing the operating mode of the current monitoring device, overcurrent mode (Hi), undercurrent mode (Lo) or window mode (In) changes the meaning of the alarm LEDs AL1 and AL2:

Communication mode	LED lights	Meaning
Hi	AL1	Prewarning overcurrent (>I)
	AL2	Alarm overcurrent (>I)
Lo	AL1	Prewarning undercurrent (<I)
	AL2	Alarm undercurrent (<I)
In	AL1	Alarm undercurrent (<I)
	AL2	Alarm overcurrent (>I)

### 3.2.2 Automatic self test

The device automatically carries out a self test after connecting to the system to be monitored and later every 24 hours. During the self test internal functional faults will be detected and appear in form of an error code on the display. The alarm relays are not switched during this test.

### 3.2.3 Manual self test

After pressing the test button for > 1.5 s, the device carries out a self test. During this test, internal functional faults are detected and will be displayed in form of an error code. The alarm relays and LEDs are checked during this test.

While holding down the test button "T", all device-relevant display elements appear on the display.

### 3.2.4 Malfunction

In the event of an internal malfunction, all three LEDs will flash. The error code (E01...E32) will appear on the display. In such a case please contact the Bender Service.

### 3.2.5 Fault memory

The fault memory can be activated, deactivated or set to continuous mode (con). If the fault memory is set to "con" mode, the alarm parameters remain stored even on failure of the supply voltage.

### 3.2.6 Setting the number of reload cycles

If faults occur only temporarily, but recurrently, in the system being monitored, with the fault memory M deactivated, the alarm relays would switch synchronously to the error status.

RL in the out menu can be used to limit the number of these changeover processes. As soon as the preset number of switching cycles is exceeded, the fault memory will come on and an activated alarm remains stored.

### 3.2.7 Erasable history memory

The first alarm value to occur is written to this memory. The memory can be erased via the HiS menu.

### 3.2.8 Assigning alarm categories to alarm relays K1/K2

Different alarm categories can be assigned to the alarm relays K1/K2 via the menu "out".



*Alarm indication of system-related failures (e.g. supply voltage not available) or a device error, requires at least one of the alarm relays, K1 or K2, to be in N/C operation mode (n.c.). In addition, the alarm category "Err" has to be assigned to the selected alarm relay in the menu out/r1 or r2.*

*If these conditions cannot be met, periodic inspection of the CMD420/CMD421 is required!*

### 3.2.9 Delay times $t$ , $t_{on}$ and $t_{off}$

The times  $t$ ,  $t_{on}$  and  $t_{off}$ , described below, delay the output of alarms via LEDs and relays.

#### Start-up delay $t$

After connection to the supply voltage, the alarm indication is delayed by the preset time  $t$  (0...300 s).

#### Response delay $t_{on1/2}$

If the response value is exceeded or not reached, the current monitoring device requires the response time  $t_{an}$  until an alarm is signalled.

A set response delay  $t_{on1/2}$  (0...300 s) adds up to the device-related operating time  $t_{ae}$  and delays alarm signalling (total delay time  $t_{an} = t_{ae} + t_{on}$ ).

Should the fault no longer persist during the response delay, the alarm signal drops out.

#### Delay on release $t_{off}$

If the alarm no longer exists during the response delay and the fault memory is deactivated, the alarm LEDs will go out and the alarm relays switch back to their initial position. After activating the release delay (0...300 s), the alarm state is continuously maintained for the selected period.

### 3.2.10 Password protection (on, OFF)

With the password protection activated (on), settings can only be made subject to the correct password being entered (0...999).

### 3.2.11 Factory setting FAC

After activating the factory setting, all previously changed settings are reset to delivery status.

### 3.2.12 Transformation ratio of the current transformers

The transformation ratio for the current transformers has to be set as factor  $n$  in the menu "Set".

The CMD420 requires current transformers with a transformation ratio of  $n = x/1A$ .

The CMD421 requires current transformers with a transformation ratio of  $n = x/5A$ .

The actual primary current can be calculated by multiplying the measured current by factor  $n$  and indicated on the display.

Transformation ratio		Resolution of the display
Factor $n$	Resolution of the settings	
1...9	1	0.01 A
10...99	1	00.1 A
100...990	10	001 A
1.00...2.00 k	0.05 k	0.01 kA

In addition, the set factor  $n$  directly affects the minimum and maximum adjustable response value thresholds in the alarm menu. The factor is the multiplier of the nominal response range!

Adjustable response value thresholds = nominal response range x factor  $n$

If the calculation of the adjustable response value results in a value of more than three digits, the first three digits indicated are not rounded.

Factor $n$	Response value range CMD420	
	min.	max.
1...9	0.10...1.00 A	0.90...9.00 A
10...99	1.0...10.0 A	9.90...99.0 A
100...990	10...100 A	99.0...990 A
1.00...2.00 k	0.10...1.00 kA	0.20...2.00 kA

Factor $n$	Response value range CMD421	
	min.	max.
1...9	0.50...5.00 A	4.50...45.0 A
10...99	5.0...50.0 A	49.5...495 A
100...990	50...500 A	495 A...4.95 kA
1.00...2.00 k	0.50...5.00 kA	1.00...10.0 kA

The resolution of the adjustable response range is calculated as follows:

Resolution of setting = factor  $n / 100$

## 4. Installation, connection and commissioning



Only **qualified personnel** are permitted to carry out the work necessary to install, commission and run a device or system.



**DANGER**

### **Risk of electrocution due to electric shock!**

Touching live parts of the system carries the risk of:

- An electric shock
- Damage to the electrical installation
- Destruction of the device

**Before installing and connecting the device, make sure that the installation has been de-energised.** Observe the rules for working on electrical installations.

### 4.1 Installing the device

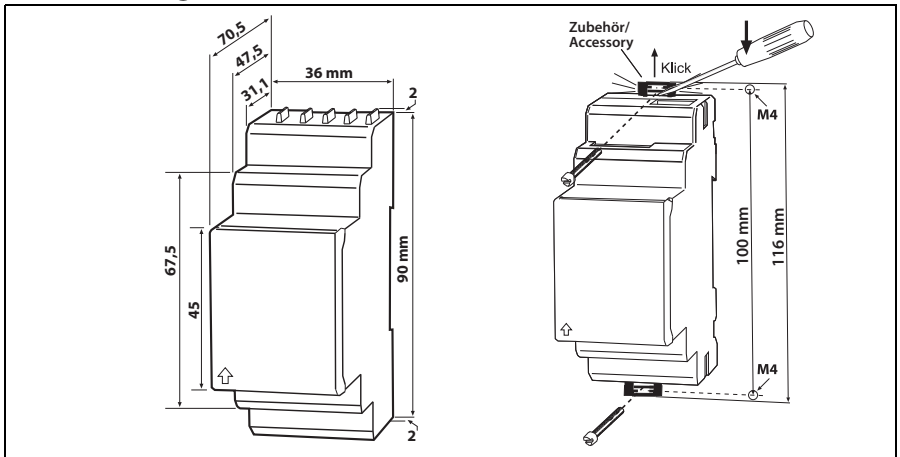

Fig. 4.1: Dimension diagram and drawing for screw fixing

#### **Mounting on DIN rail:**

Snap the rear mounting clip of the device into place in such a way that a safe and tight fit is ensured.

#### **Screw fixing:**

Use the tool to move the rear mounting clips (a second. mounting clip is required, see ordering information) to a position that it projects beyond the enclosure. Then fix the device using two M4 screws.

## 4.2 Connection of the device

Connect the device according to the wiring diagram.

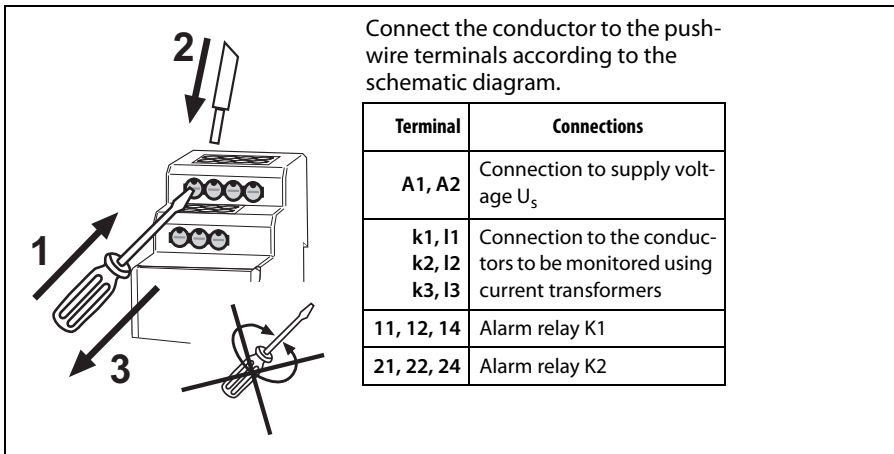
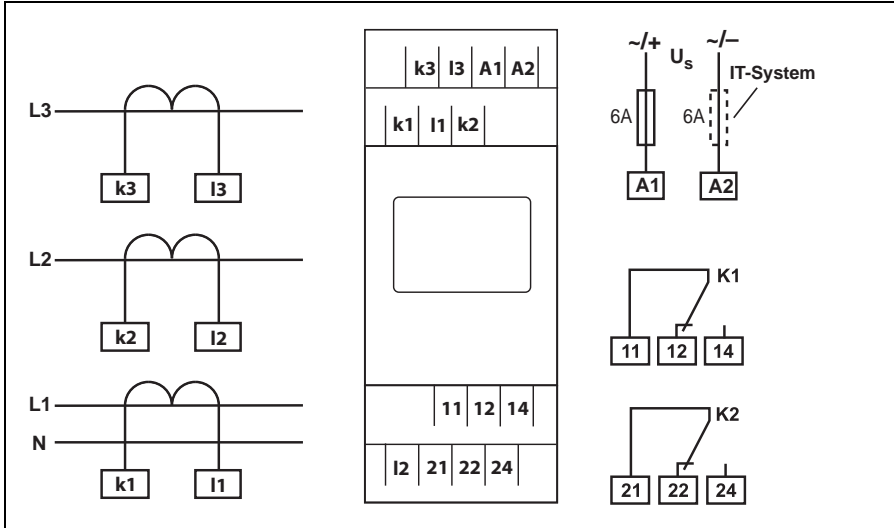



### 4.3 Commissioning

Checks must be carried out prior to commissioning to ensure that the current monitoring device has been connected correctly. Then perform a functional test.



CAUTION

*Incorrect connections can lead to personal injury and damage to equipment or property!*



*The maximum permissible measuring current and the overload capability of the measuring inputs k, l have to be taken into consideration!*

### 4.4 Factory setting



#### **CMD420**

Response value overcurrent I1 (prewarning) 0.15 A (50 % of I2)  
Response value overcurrent I2 (alarm) 0.30 A

#### **CMD421**

Response value overcurrent I1 (prewarning) 0.75 A (50 % of I2)  
Response value overcurrent I2 (alarm) 1.50 A

#### **CMD420 / CMD421**

Hysteresis:	15 %
Fault memory M:	activated (on)
Operating mode K1/K2	N/C operation (n.c.)
Reload cycles	0
Alarm assignment K1	Error (Err), response value I1, manual test (tES)
Alarm assignment K2	Error (Err), response value I2, manual test (tES)
Response delay:	$t_{on1} = 1 \text{ s}$ $t_{on2} = 0 \text{ s}$ $t = 0.5 \text{ s}$
Start-up delay:	$t_{off} = 1 \text{ s}$
Delay on release:	Overcurrent (HI)
Monitoring function:	1
Transformation ratio n	0, deactivated (Off)
Password:	

## 4.5 Maintenance



*One alarm relay of the CMD420 CMD421 must work in N/C operation with the alarm category "Err" assigned to this relay, otherwise periodic inspection will be necessary!*

A functional test is recommended to be carried out at regular intervals. It is preferable to check correct alarm indication by means of a current fault.



Also check that the terminal connections are mechanically secure.

## 5. Operation and configuration

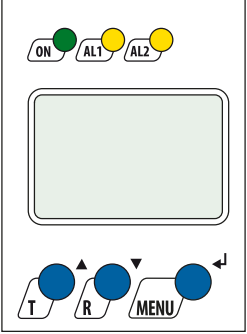
### 5.1 Operating elements

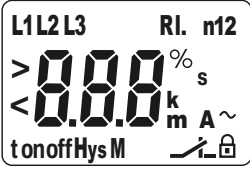

Device front	Element	Mode
	<b>ON</b>	Power On LED, green
	<b>AL1</b>	LED Alarm 1 lit up (yellow): Response value 1 reached
	<b>AL2</b>	LED Alarm 2 lit up (yellow): Response value 2 reached
	▲	Up button (< 1.5 s): Menu items/values
	T	Test button (> 1.5 s): to indicate the display elements in use, to start a self test;
	▼	Down button (< 1.5 s): Menu items/value Reset button (> 1.5 s): Deactivating the fault memory;
R	<b>MENU</b> MENU button (> 1.5 s): To start the menu mode; Enter button (< 1.5 s): To confirm menu item, submenu item and value. Enter button (> 1.5 s): Move to the next higher menu level (back)	

## 5.2 Display elements in use

Display elements in use	Element	Mode
 <p>The screenshot shows a digital display with the following elements:                     <ul style="list-style-type: none"> <li>Top left: L1 L2 L3</li> <li>Top right: RI. n12</li> <li>Center: &gt; 000 % s</li> <li>Center: &lt; 000 k m A ~</li> <li>Bottom left: t on off Hys M</li> <li>Bottom right: A lock icon</li> </ul> </p>	L1, L2, L3	Values of the measurement inputs k1/I1, k2/I2, k3/I3
	RL	Reload function with memory = off (L = I.)
	n	Transformation ratio for external current transformer
	< I12 > I12	Undercurrent I1 or I2 Overcurrent I1 or I2
	r1, 1 r2, 2	Alarm relay K1, Alarm relay K2
	I Hys %, Hys	Response value hysteresis in %; <b>Hys</b> in standard mode: Measured value in the hysteresis range according to alarm
	ton1, ton2, T, toff	Response delay $t_{on1}$ (K1), Response delay $t_{on2}$ (K2) Start-up delay t Delay on release $t_{off}$ for K1, K2
	M	Fault memory active
		Operating mode for relays K1, K2
		Password protection enabled

### 5.3 Menu structure

All adjustable parameters are listed in the columns "Menu" and "Adjustable parameters". A display-like representation is used to illustrate the parameters in the column Menus. Different alarm categories can be assigned to the alarm relays K1, K2 via the submenus r1, r2. This is done by activation or deactivation of the respective function.

Menu	Sub Menu	Menu item	Activation	Adjustable parameter	
AL (response values)	→	> I2	ON (HI)	Overcurrent (alarm)	
		> I1	ON (HI)	Overcurrent (prewarning)	
		I Hys		Hysteresis < I21, > I21	
out (output control)	→	M	ON	Fault memory	
		 1	-	Operating mode K1 (n.c.)	
		 2	-	Operating mode K2 (n.c.)	
		RL		Reload function (memory = off)	
	r1 (K1: (assignment alarm category))		1 Err	ON	Device error at K1
			r1 I1	ON	Prewarning I1 at K1
			r1 I2	off	Alarm I2 at K1
			1 tES	ON	Device test
	r2 (K2: (assignment alarm category))		2 Err	ON	Device error at K2
			r2 I1	off	Prewarning I1 at K2
			r2 I2	ON	Alarm I2 at K2
			2 tES	ON	Device test
	t (timing check)	→	t on 1	-	Response delay K1
t on 2			-	Response delay K2	
t			-	Start-up delay	
t off			-	Delay on release K1/K2	
Set (device control)	→	I 12	HI	Selectable parameters: Hi= overcurrent, In = window function, Lo = undercurrent	
		n	1	Transformation ratio external current transformer	
			off	Set parameters via password	
		FAC	-	Factory setting visual inspection	
		SYS	-	Function locked	
InF	→		-	Display software version	
HiS	→	Clr	-	History memory for the first alarm value, erasable	

## 5.4 Display in standard mode

By default, the currently measured current of measuring channel L1 is displayed.

By pressing the Down button the following values can be queried consecutively:

- Current of measuring channel L2
- Current of measuring channel L3
- Response value I1 (prewarning)
- Response value I2 (alarm)

Pressing the Up button shows the corresponding values in the reverse order.

You can also press the Enter button to return from the response value display to the measured value display.

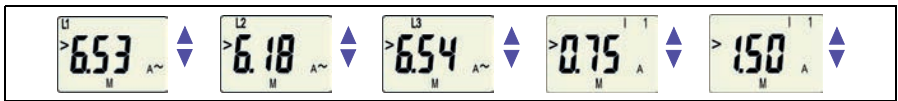

*In the standard mode, the currently set measured values and response values can be displayed using the Up and Down buttons.*

## 5.5 Display in menu mode

### 5.5.1 Parameter query and setting: overview

Menu item	Adjustable parameter
<b>AL</b>	Response value query and setting: <ul style="list-style-type: none"> <li>- Alarm I2 (AL2), (undercurrent, overcurrent or window function can be set in the Set/I menu)</li> <li>- Prewarning I1 (AL1), (X % of I2)</li> <li>- Specify the hysteresis of the response values: Hys I12</li> </ul>
<b>out</b>	Configure the fault memory and the alarm relays: <ul style="list-style-type: none"> <li>- Activate/deactivate the fault memory or select con mode</li> <li>- Select N/O operation (n.o.) or N/C operation (n.c.) individually for each K1/K2</li> <li>- Specify the number of the reload cycles</li> <li>- Assign the alarm categories undercurrent or overcurrent or device error individually to each K1/K2 (1, r1 / 2, r2).</li> </ul>
<b>t</b>	Delay settings: <ul style="list-style-type: none"> <li>- Response delay <math>t_{on1}/t_{on2}</math></li> <li>- Start-up delay <math>t</math></li> <li>- Delay on release <math>t_{off}</math> (LED, relay)</li> </ul>
<b>Set</b>	Set parameters for device control: <ul style="list-style-type: none"> <li>- Select the appropriate parameter for response values: overcurrent (HI), undercurrent (Lo) or window function (In)</li> <li>- Set the transformation ratio (n) for the current transformer</li> <li>- Activate or deactivate password protection, change password</li> <li>- Restore factory settings</li> <li>- Service menu SyS blocked</li> </ul>
<b>InF</b>	Query software version
<b>HiS</b>	Query the alarm value saved first
<b>ESC</b>	Go to the next highest menu level (back)

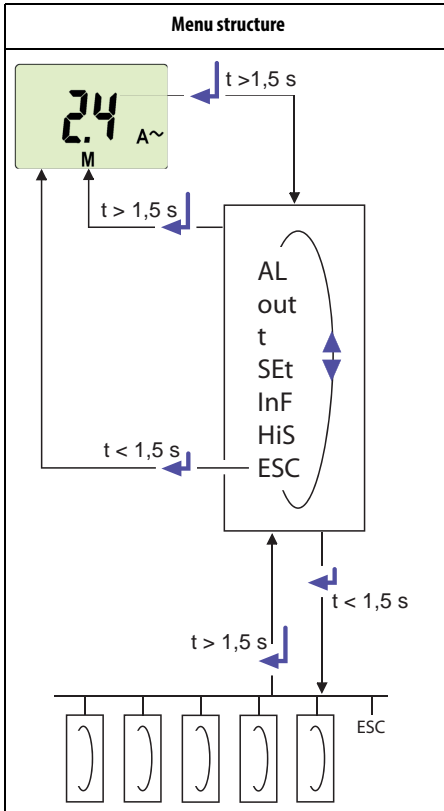

### Parameter settings

An example is given below on how to change the alarm response value for overcurrent > I1. It is presumed that the option overcurrent (HI) has been selected in the SEt/I menu (factory setting). Proceed as follows:

1. Keep the "MENU / Enter" button pressed for more than 1.5 seconds. The flashing short symbol AL appears on the display.
2. Confirm with Enter. The parameter response value I2 flashes, in addition the associated overcurrent value appears.
3. Use the Down button to select the parameter response value I1. The parameter I1 flashes, in addition the associated percentage value for prewarning of I2 appears.
4. Confirm with Enter. The current value for prewarning appears on the flashing display.



5. Use the Up or Down button to set the appropriate prewarning value. Confirm with Enter. I1 flashes.
6. You can exit the menu by:
  - pressing the Enter button for more than 1.5 seconds to reach the next higher level or
  - selecting the menu item ESC and confirming with Enter to reach the next higher level.



*The currently active segments of the display which can be configured are flashing! These segments are highlighted by an oval in the illustrations below. Press and hold down the MENU button > 1.5 s to enter menu mode.*

### 5.5.2 Changeover from overcurrent to undercurrent mode or to window mode

The operating mode can be set in the SEt/I12 menu using the parameters HI, Lo and In. By default, overcurrent operation (HI) is set. Refer to page 30 for a detailed description on how to change over to the window mode.

### 5.5.3 Response value setting for overcurrent:

- Response value I2 (overcurrent)
- Response value I1 (overcurrent)
- Hysteresis (Hys) of the response values I1, I2

#### Increasing the response value I2 (Example: overcurrent)

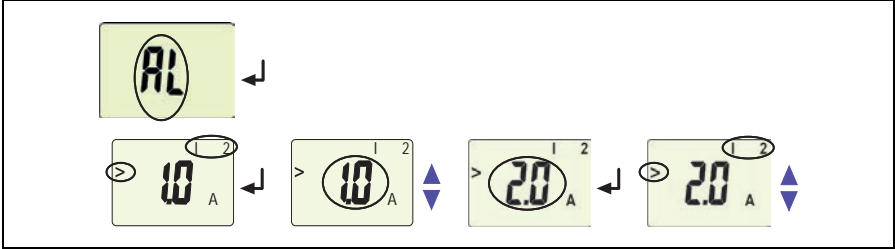

#### Increasing the response value I1 (prewarning overcurrent)

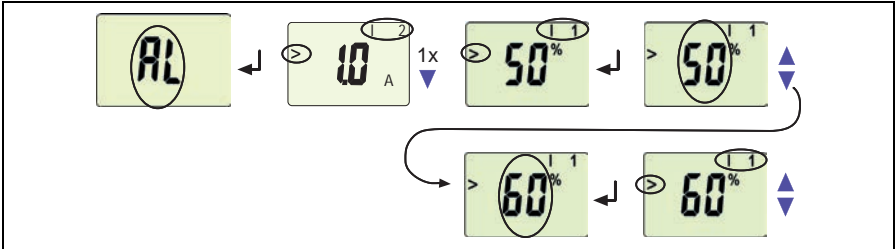

#### Setting the hysteresis of the response value

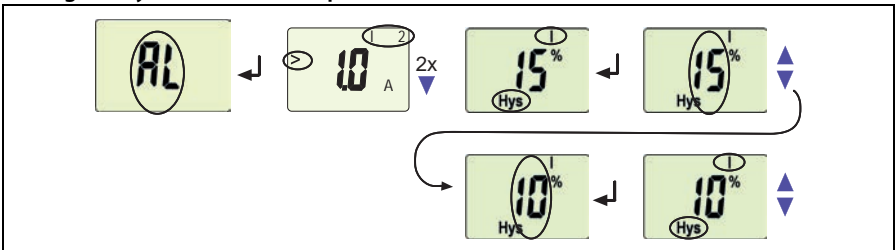

### 5.5.4 Setting the fault memory and alarm relay operating mode

#### Setting the fault memory to con mode

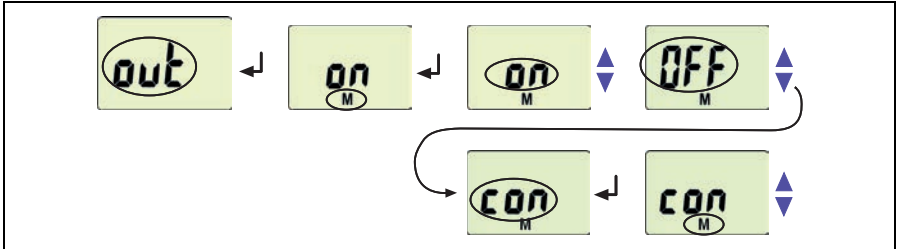

#### Setting the alarm relay K1 to N/O operation (n.o.)

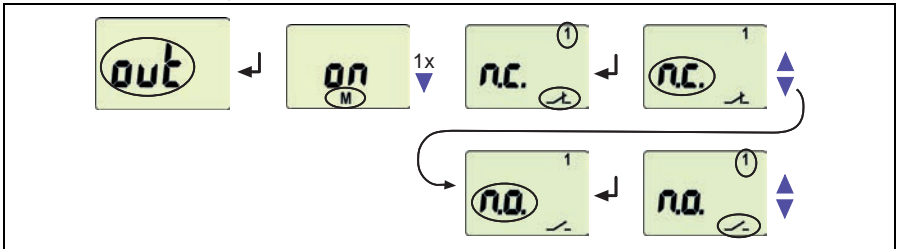

#### Setting the number of reload cycles

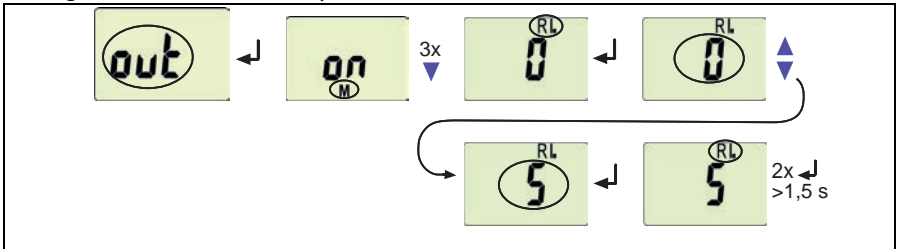

### 5.5.5 Assigning alarm categories to the alarm relays

Overcurrent, undercurrent and device-related errors of the current monitor can be assigned to the alarm relays K1 (r1, 1) and K2 (r2, 2). By default, the alarm relays K1 and K2 signal prewarning and alarm in case of overcurrent.

#### Alarm relay K1: Deactivating the category device error

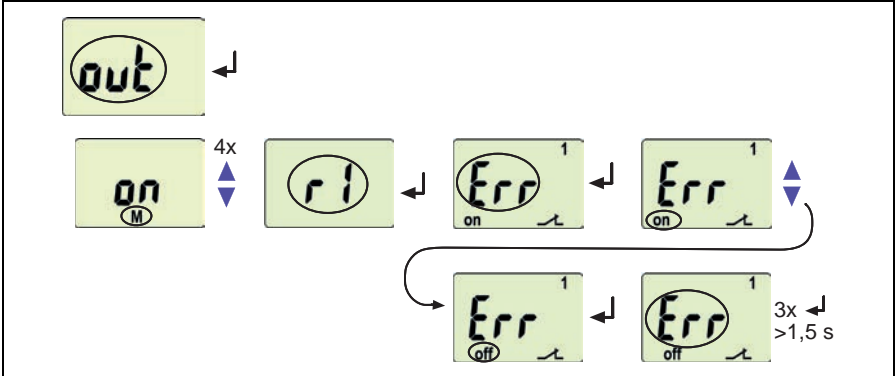

#### Alarm relay K1: Deactivating the category response value I1

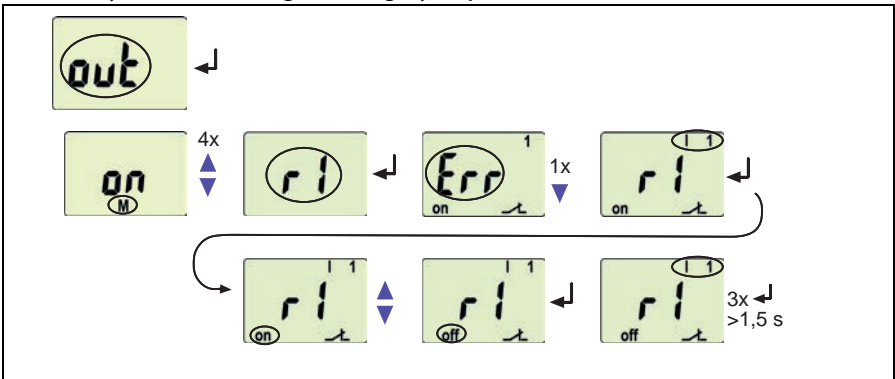

**Alarm relay K1: Activating the category response value I2**

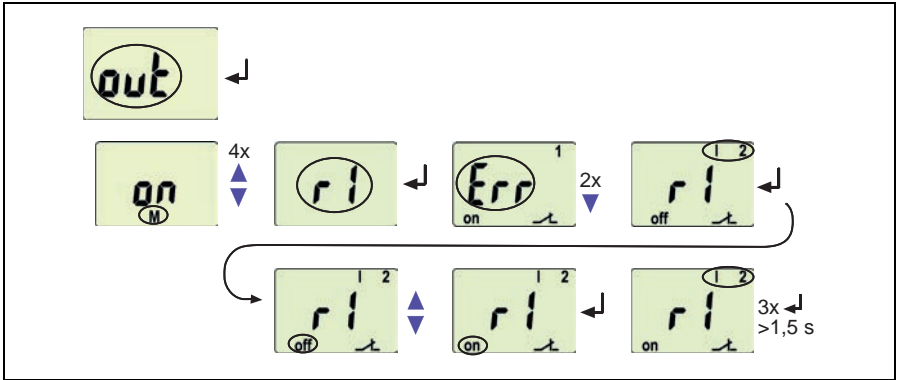

**Alarm relay K1: Deactivating the category device test**

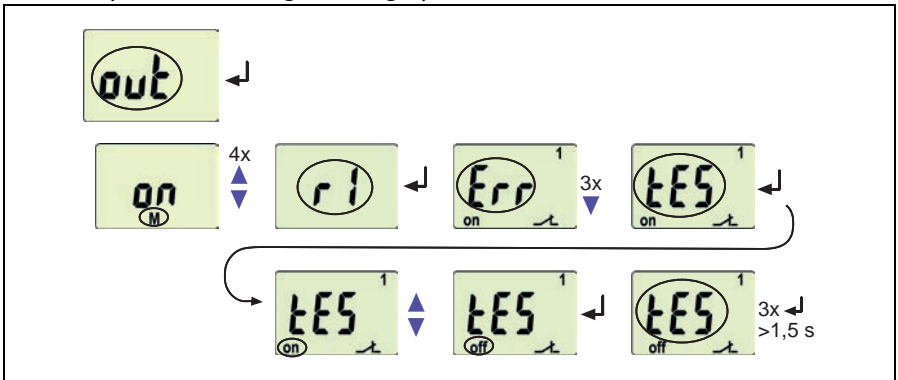

*Deactivating an alarm relay (K1/K2) via the menu prevents an alarm being indicated by the respective changeover contact!  
An alarm will be signalled by the respective alarm LED (AL1/AL2) only!*

**5.5.6 Setting time delays**

The following delays can be set:

- Response delay  $t_{on1}$  (0...300 s) for K1, and  $t_{on2}$  (0...300 s) for K2
- Start-up delay  $t$  (0...300 s) when the device is being started
- Common delay on release  $t_{off}$  (0...300 s) for K1, K2. The setting  $t_{off}$  is only relevant when the fault memory M is deactivated.

The control steps for setting the response delay  $t_{on1}$  and the start-up delay  $t$  are shown as an example.

#### Setting the response delay $t_{on1}$

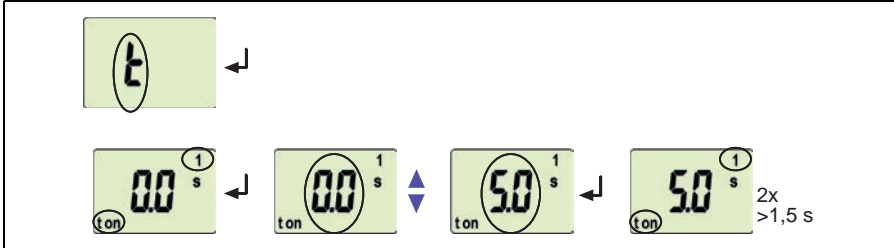

#### Setting the start-up delay $t$

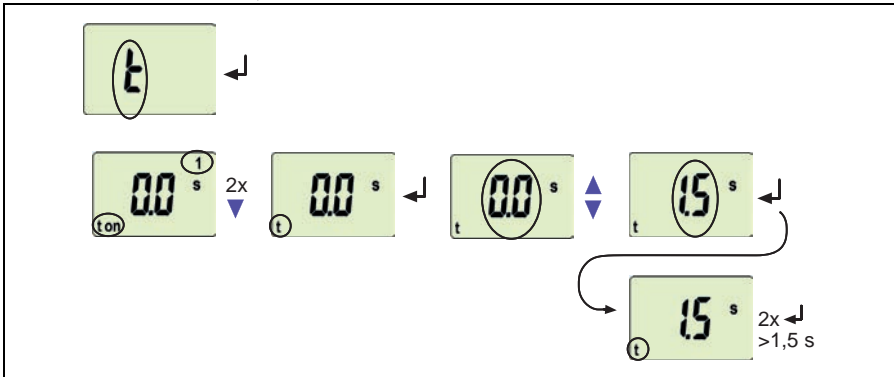

### 5.5.7 Changing from overcurrent operation to window operation

Use this menu item to set whether the response values of the device apply to overcurrent (HI) or undercurrent operation (Lo). In addition, window operation (In) can be selected.

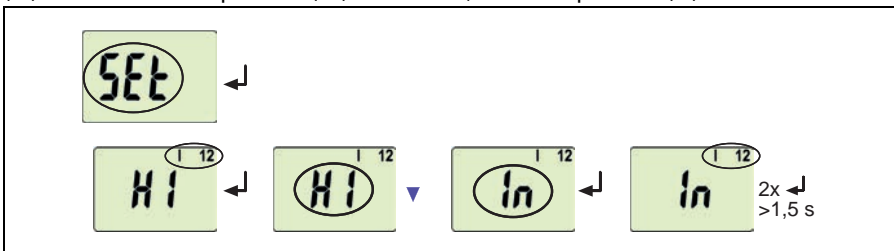

### 5.5.8 Setting the transformation ratio for external current transformer

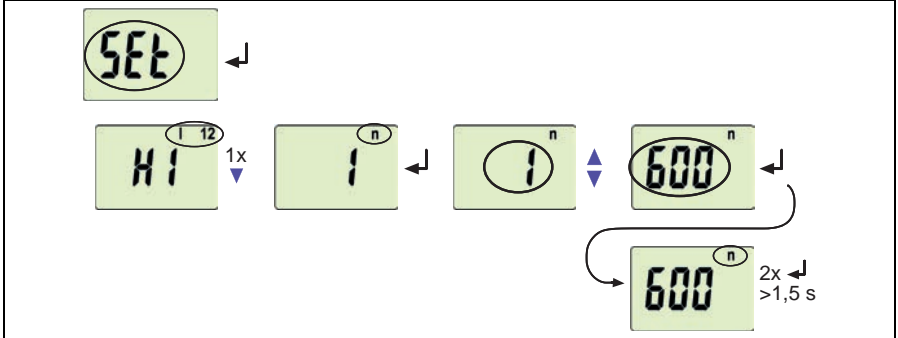

### 5.5.9 Factory setting and password protection

This menu can be used to activate password protection, to modify the password or to deactivate password protection. It is also where the device can be reset to the factory settings.

a) Activating the password protection

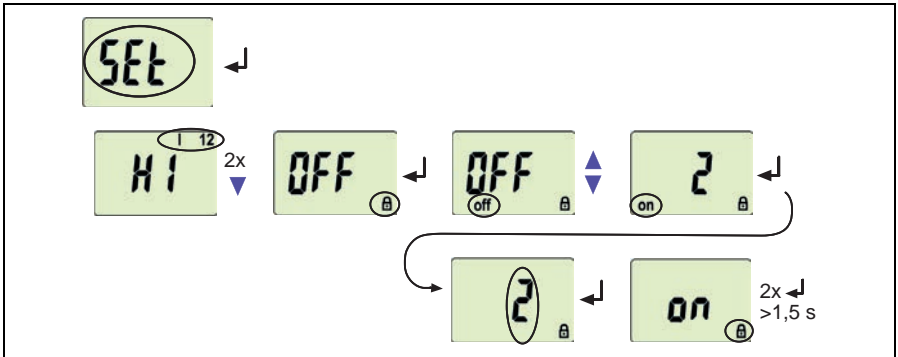

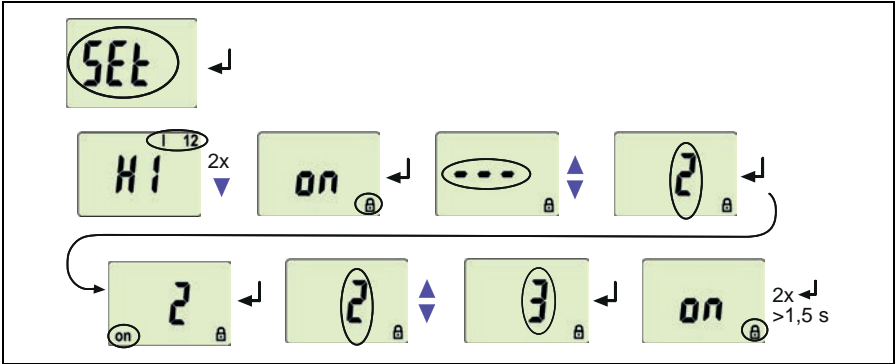
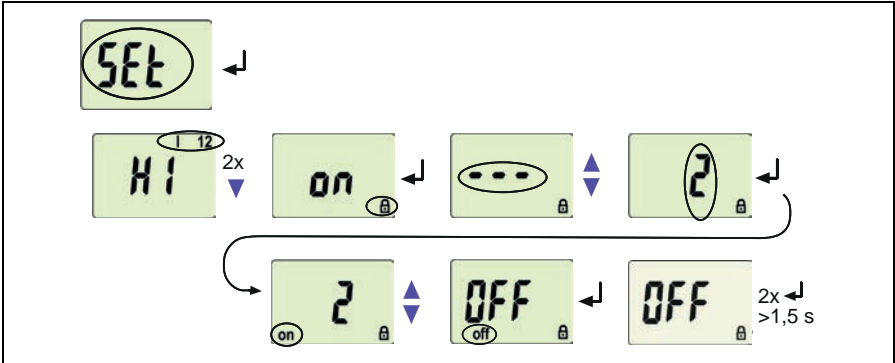
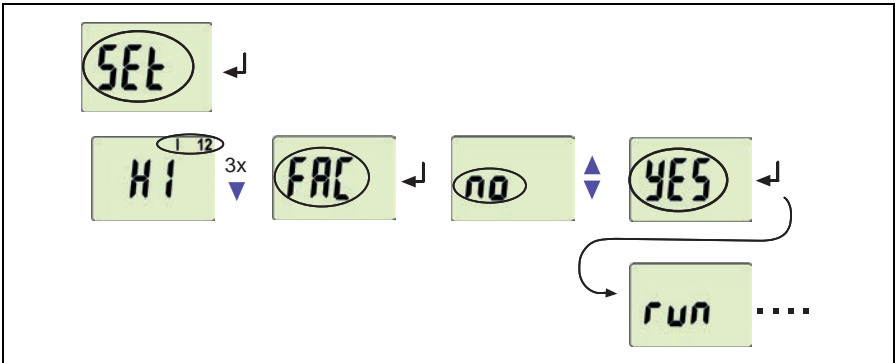
**b) Change password**

**c) Deactivate password protection**

**5.5.10 Restore factory setting**

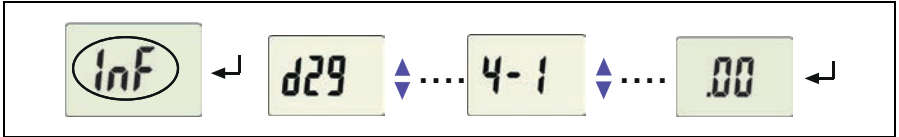

### 5.5.11 Device information query

This function is used to query the software version (1.xx). After activating this function, data will be displayed as a scrolling text. Once one pass is completed you can select individual data sections using the Up/Down buttons.



### 5.5.12 History memory query

Select the history memory via the menu HiS. Use the Up and Down buttons to view the next display. If Clr is flashing, the history memory can be cleared by pressing the Enter button.

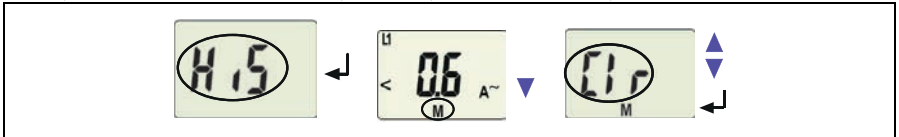



## 6. Technical data

### 6.1 Data in tabular form

( ) \* = factory setting

#### Insulation coordination acc. to IEC 60664-1/IEC 60664-3

CMD420...:

Rated insulation voltage.....	AC 250 V
Rated impulse voltage/pollution degree .....	6 kV / III
Protective separation (reinforced insulation) between.....	(A1, A2) - (k, l) - (11, 12, 14) - (, 21, 22, 24)
Protective separation (reinforced insulation) between.....	(k1, l1, k2, l2, k3, l3) - (11, 12, 14)
Voltage test acc. to IEC 61010-1 .....	3.536 kV

CMD421...:

Rated insulation voltage.....	AC 250 V
Rated impulse voltage/pollution degree .....	4 kV / III
Basic insulation between:.....	(k1, l1, k2, l2, k3, l3) - (A1, A2), (21, 22, 24)
Basic insulation between:.....	(11, 12, 14) - (21, 22, 24)
Voltage test acc. to IEC 61010-1 .....	2.21 kV

#### Supply voltage

CMD420-D-1, CMD421-D-1:

Supply voltage $U_s$ .....	AC 16...72 V / DC 9.6...94 V
Frequency range $U_s$ .....	15...460 Hz

CMD420-D-2, CMD421-D-2:

Supply voltage $U_s$ .....	AC / DC 70...300 V
Frequency range $U_s$ .....	15...460 Hz
Power consumption .....	≤ 4 VA

#### Measuring circuit CMD420

Nominal measuring range (r.m.s. value) $n = 1$ .....	AC 0...1 A
Overload capability, continuous.....	2 A
Overload capability < 5 s .....	5 A
Load per measuring input .....	50 mΩ
Rated frequency $f_n$ .....	42...460 Hz

**Response values CMD420**

Undercurrent $I_o < I$ (Alarm 2) $n = 1$ .....	AC 0.1 ... 1 A (0.3 A)*
Undercurrent $I_o < I$ (Alarm 1) $n = 1$ .....	100 ... 200 % (150 %)*
Take a maximum nominal current of 1 A into consideration!	
Overcurrent $I_i > I$ (Alarm 2) $n = 1$ .....	AC 0.1 ... 1 A (0.3 A)* (Hi)*
Overcurrent $I_i > I$ (Alarm 1) $n = 1$ .....	50 ... 100 % (50 %)* (Hi)*
Window $I_n > I$ (Alarm 2) $n = 1$ .....	AC 0.1 ... 1 A (0.3 A)*
Window $I_n < I$ (Alarm 1) $n = 1$ .....	50 ... 100 % (50 %)*
External current transformer .....	x/1 A
Transformation ratio $n$ .....	1 ... 2000 (1)*
Relative uncertainty in the range of 42 ... 460 Hz .....	$\pm 5$ %, $\pm 2$ digits
Hysteresis .....	3 ... 40 % (15 %)*

**Measuring circuit CMD421**

Nominal measuring range (r.m.s. value) .....	AC 0 ... 5 A
Overload capability, continuous .....	7.5 A
Overload capability $< 5$ s .....	for screw-type terminal connection 20 A
.....	for push-wire terminal connection 12 A
Load per measuring input .....	3 m $\Omega$
Rated frequency $f_n$ .....	42 ... 460 Hz

**Response values CMD421**

Undercurrent $I_o < I$ (Alarm 2) $n = 1$ .....	AC 0.5 ... 5 A (1.5 A)*
Undercurrent $I_o < I$ (Alarm 1) $n = 1$ .....	100 ... 200 % (150 %)*
Take a maximum nominal current of 5 A into consideration!	
Overcurrent $I_i > I$ (Alarm 2) $n = 1$ .....	AC 0.5 ... 5 A (1.5 A)* (Hi)*
Overcurrent $I_i > I$ (Alarm 1) $n = 1$ .....	50 ... 100 % (50 %)* (Hi)*
Window $I_n > I$ (Alarm 2) $n = 1$ .....	AC 0.5 ... 5 A (1.5 A)*
Window $I_n < I$ (Alarm 1) $n = 1$ .....	50 ... 100 % (50 %)*
External current transformer .....	x/5 A
Transformation ratio $n$ .....	1 ... 2000 (1)*
Relative uncertainty in the range of 42 ... 460 Hz .....	$\pm 5$ %, $\pm 2$ digits
Hysteresis .....	3 ... 40 % (15 %)*

**Time response**

Start-up delay $t$ .....	0 ... 300 s (0.5 s)*
Response delay $t_{on1}$ .....	0 ... 300 s (1 s)*
Response delay $t_{on2}$ .....	0 ... 300 s (0 s)*
Delay on release $t_{off}$ .....	0 ... 300 s (1 s)*
Resolution of setting $t, t_{on1/2}, t_{off}$ (0 ... 10 s) .....	0.1 s
Resolution of setting $t, t_{on1/2}, t_{off}$ (10 ... 99 s) .....	1 s
Resolution of setting $t, t_{on1/2}, t_{off}$ (100 ... 300 s) .....	10 s
Operating time $t_{ae}$ .....	≤ 130 ms
Response time $t_{an}$ .....	$t_{an} = t_{ae} + t_{on1/2}$
Device release time $t_{re}$ .....	≤ 135 ms
Release time $t_{off}$ .....	$t_{off} = t_{re} + t_{off}$
Recovery time $t_b$ .....	≤ 300 ms

**Displays, memory**

Display .....	LC display, multifunctional, not illuminated
Display range, measured value (r.m.s. value) x transformation ratio n .....	CMD420: AC 0 ... 1 A x n
.....	CMD421: AC 0 ... 5 A x n
Relative uncertainty in the range of 42 ... 460 Hz .....	±5 %, ±2 digits
Measured-value memory (HiS) for the first alarm value .....	data record measured values
Password .....	on/off / 0 ... 999 (OFF)*
Fault memory (M) alarm relay .....	on / off / con (on)*

**Switching elements**

Number .....	2 x 1 changeover contacts (K1, K2)
Operating principle .....	N/C operation / N/O operation
K1: .....	Err, I1, I2, tES (device error Err, overcurrent prewarning > I1, test button tES)*
K2: .....	Err, I1, I2, tE (device error Err, overcurrent alarm > I2, test button tES)*
Electrical service life under rated operating conditions .....	10000 switching operations
Contact data acc. to IEC 60947-5-1:	
Utilisation category .....	AC 13 / AC 14 / DC-12 / DC-12 / DC-12
Rated operational voltage .....	230 / 230 V / 24 V / 110 V / 220 V
Rated operational current .....	5 A / 3 A / 1 A / 0,2 A / 0,1 A
Minimum contact rating .....	1 mA at AC/DC ≥ 10 V

**Environment/EMC**

EMC .....	IEC 61326-1
Operating temperature .....	-25 ... +55 °C
Classification of climatic conditions acc. to IEC 60721:	
Stationary use (IEC 60721-3-3) .....	3K23 (except condensation and formation of ice)
Transportation (IEC 60721-3-2) .....	2K11 (except condensation and formation of ice)
Storage (IEC 60721-3-1) .....	1K22 (except condensation and formation of ice)
Classification of mechanical conditions acc. to IEC 60721:	
Stationary use (IEC 60721-3-3) .....	3M11
Transportation (IEC 60721-3-2) .....	2M4
Storage (IEC 60721-3-1) .....	1M12

**Connection****Screw-type terminals**

Connection properties: .....	
rigid / flexible .....	0.2 ... 4 / 0.2 ... 2.5 mm <sup>2</sup> (AWG 24 ... 12)
Multi-conductor connection (2 conductors with the same cross section): .....	
rigid / flexible .....	0.2 ... 1.5 / 0.2 ... 1.5 mm <sup>2</sup> (AWG 24 ... 16)
Stripping length .....	8 ... 9 mm
Tightening torque .....	0.5 ... 0.6 Nm

**Push-wire terminals**

Connection properties: .....	
rigid .....	0.2 ... 2.5 mm <sup>2</sup> (AWG 24 ... 14)
Flexible without ferrules .....	0.75 ... 2.5 mm <sup>2</sup> (AWG 19 ... 14)
Flexible with ferrules .....	0.2 ... 1.5 mm <sup>2</sup> (AWG 24 ... 16)
Stripping length .....	10 mm
Opening force .....	50 N
Test opening, diameter .....	2.1 mm

**Other**

Operating mode .....	continuous operation
Position .....	any position
Degree of protection, internal components (DIN EN 60529) .....	IP30
Degree of protection, terminals (DIN EN 60529) .....	IP20
Enclosure material .....	polycarbonate
Flammability class .....	UL94 V-0
DIN rail mounting acc. to .....	IEC 60715
Screw fixing .....	2 x M4 with mounting clip
Software version CMD420 .....	D287 V1.1x
Software version CMD421 .....	D294 V1.1x
Weight .....	≤ 150 g

## 6.2 Standards, approvals and certifications



## 6.3 Label for modified versions

There will only be a label in this field, if the device is different from the standard version.



## 6.4 Ordering details

Device type	Supply voltage $U_s^*$	Response value	Art. No.
CMD420-D-1 (push-wire terminals)	AC 16...72 V / DC 9.6 V...94 V DC15...460 Hz	0.1...1 A x n	B73060006
CMD420-D-1	AC 16...72 V / DC 9.6 V...94 V DC15...460 Hz	0.1...1 A x n	B93060006
CMD420-D-2 (push-wire terminals)	AC/DC 70...300 V 15...460 Hz	0.1...1 A x n	B73060007
CMD420-D-2	AC/DC 70...300 V 15...460 Hz	0.1...1 A x n	B93060007
CMD421-D-1 (push-wire terminals)	AC 16...72 V / DC 9.6 V...94 V DC15...460 Hz	0.5...5 A x n	B73060008
CMD421-D-1	AC 16...72 V / DC 9.6 V...94 V DC15...460 Hz	0.5...5 A x n	B93060008
CMD421-D-2 (push-wire terminals)	AC/DC 70...300 V 15...460 Hz	0.5...5 A x n	B73060009
CMD421-D-2	AC/DC 70...300 V 15...460 Hz	0.5...5 A x n	B93060009
*Absolute values of the voltage range			
<b>Mounting clip for screw mounting (1 piece per device, accessories)</b>			B 9806 0008

## 6.5 Revision history

Date	Document-version	Valid from software	State/Changes
10.2021	01	-	Editorial revision New design with format change from DIN A6 to DIN A5 S. 38 Update of the climate classes according to EN IEC 60721-3-4:2019 S. 40 Revision history



## INDEX

### A

Adjustable parameters, list 21  
Automatic self test 12

### D

Delay on release toff 13  
Deleting the fault alarms 20  
Description of function 11  
Device features 11  
Display elements in use 19  
Display in standard mode 22

### E

Enter button 20  
Example of parameter setting 24

### F

Factory setting 13, 17

### G

Getting to know the user interface  
20

### H

How to use this manual 5

### I

Installation and connection 15  
Intended use 9

### K

K1: assignment alarm category 21  
K2: assignment alarm category 21

### L

LED Alarm 1 lights 20  
LED Alarm 2 lights 20

### M

Malfunction 12  
  
Manual self test 12  
Menu  
- AL (response values) 21  
- HiS (history memory for the  
first alarm value) 21  
- InF (hard and software ver-  
sion) 21  
- out (output control) 21  
- Set (device control) 21  
- t (timing check) 21  
Menu structure, overview 21  
Mounting clip for screw mounting  
39

### O

Operation and configuration 19  
Ordering information 39

### P

Parameter query and setting, over-  
view 23  
Parameter setting  
- Activating or deactivating the  
password protection 31  
- Activating fault memory 27  
- Assigning alarm categories to

the alarm relays 28  
- Changeover from overcurrent  
operation to window opera-  
tion 30  
- Response value setting 26  
- Setting time delays 29

Password protection 13

### R

Reset button 20  
Response delay ton 13  
Response value setting  
- Hysteresis 26  
- Overcurrent (> I) 26

### S

Service 5  
Setting the number of reload cycles  
27  
Starting the menu mode 20  
Start-up delay t 13  
Support 5

### T

Technical data 35  
Test button 20  
Training courses 6

### W

Window discriminator function 11  
Wiring diagram 16  
Work activities on electrical  
installations 9  
Workshops 6







**Bender GmbH & Co. KG**

P.O. Box 1161 • 35301 Grünberg • Germany  
Londorfer Str. 65 • 35305 Grünberg • Germany  
Tel.: +49 6401 807-0 • Fax: +49 6401 807-259  
E-Mail: [info@bender.de](mailto:info@bender.de) • [www.bender.de](http://www.bender.de)

© Bender GmbH & Co. KG

All rights reserved.

Reprint only with permission of the publisher.

Subject to change without notice!

Photos: Bender archives



**BENDER Group**